



COLLETTORI

PER RISCALDAMENTO E RAFFRESCAMENTO A PAVIMENTO,
RISCALDAMENTO TRADIZIONALE E SANITARI

COLLETTORE PRE-ASSEMBLATO DI DISTRIBUZIONE PER IMPIANTI DI RISCALDAMENTO

Consente:

1. Precisione nel controllo e nella regolazione della portata dei singoli circuiti
2. Controllo della temperatura dei collettori di mandata e di ritorno
3. Ridotte perdite di carico
4. Intercettazione dei singoli circuiti
5. Facilità di installazione



CODICE

88.10.120/130

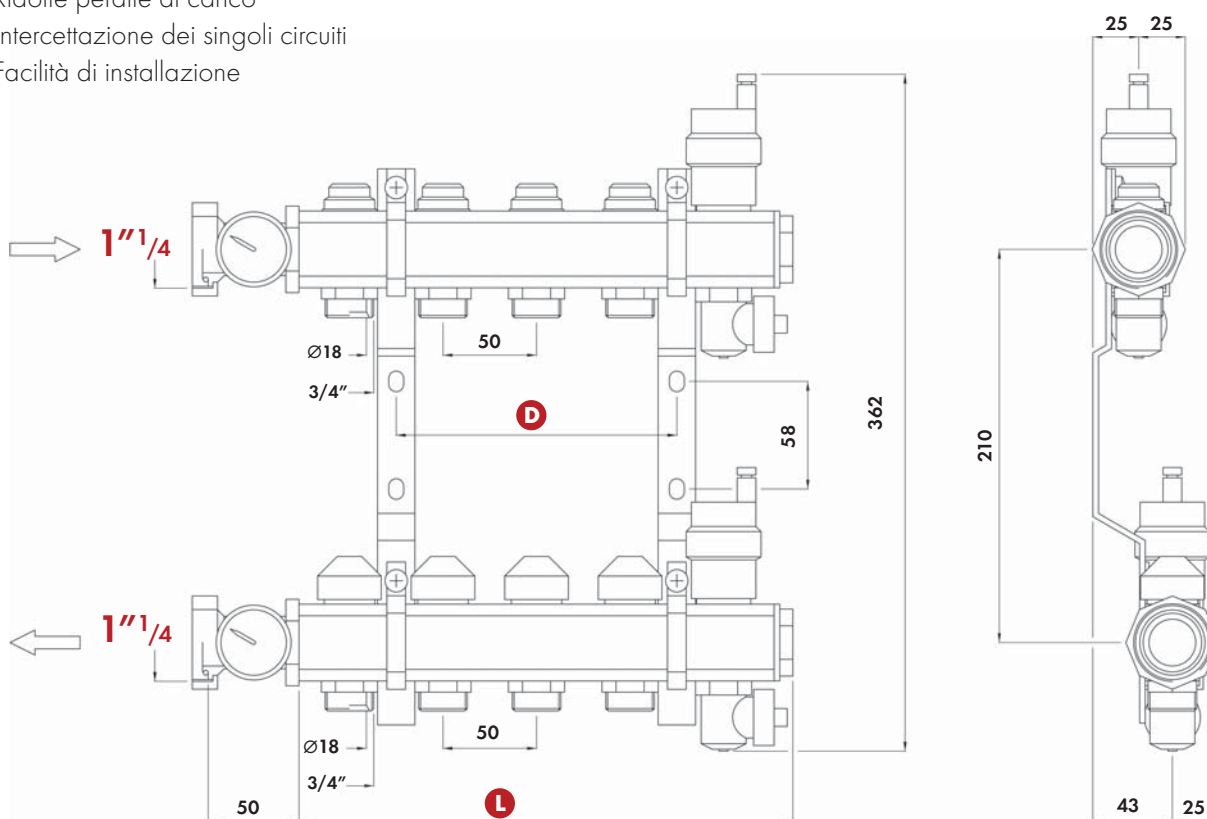

DIMENSIONI ED INGOMBRI

CODICE COLLETTORE	N. USCITE	L (mm)	D (mm)	CODICE CASSETTA
88.10.120	2	164	50	88.10.315
88.10.121	3	214	100	88.10.315
88.10.122	4	264	150	88.10.315
88.10.123	5	314	200	88.10.315
88.10.124	6	364	250	88.10.320
88.10.125	7	414	300	88.10.320
88.10.126	8	464	350	88.10.320
88.10.127	9	514	400	88.10.320
88.10.128	10	564	450	88.10.325
88.10.129	11	614	500	88.10.325
88.10.130	12	664	550	88.10.325

COLLETORE PRE-ASSEMBLATO DI DISTRIBUZIONE PER IMPIANTI DI RISCALDAMENTO

Consente:

1. Precisione nel controllo e nella regolazione della portata dei singoli circuiti
2. Facilità ed immediatezza nel monitoraggio della portata dei singoli circuiti
3. Controllo della temperatura nei collettori di mandata e di ritorno
4. Ridotte perdite di carico
5. Intercettazione dei singoli circuiti
6. Facilità di installazione

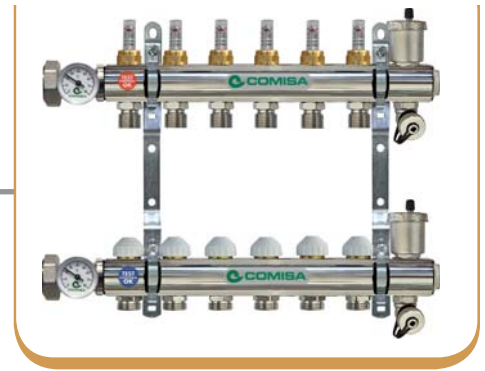

CODICE

88.10.140/150

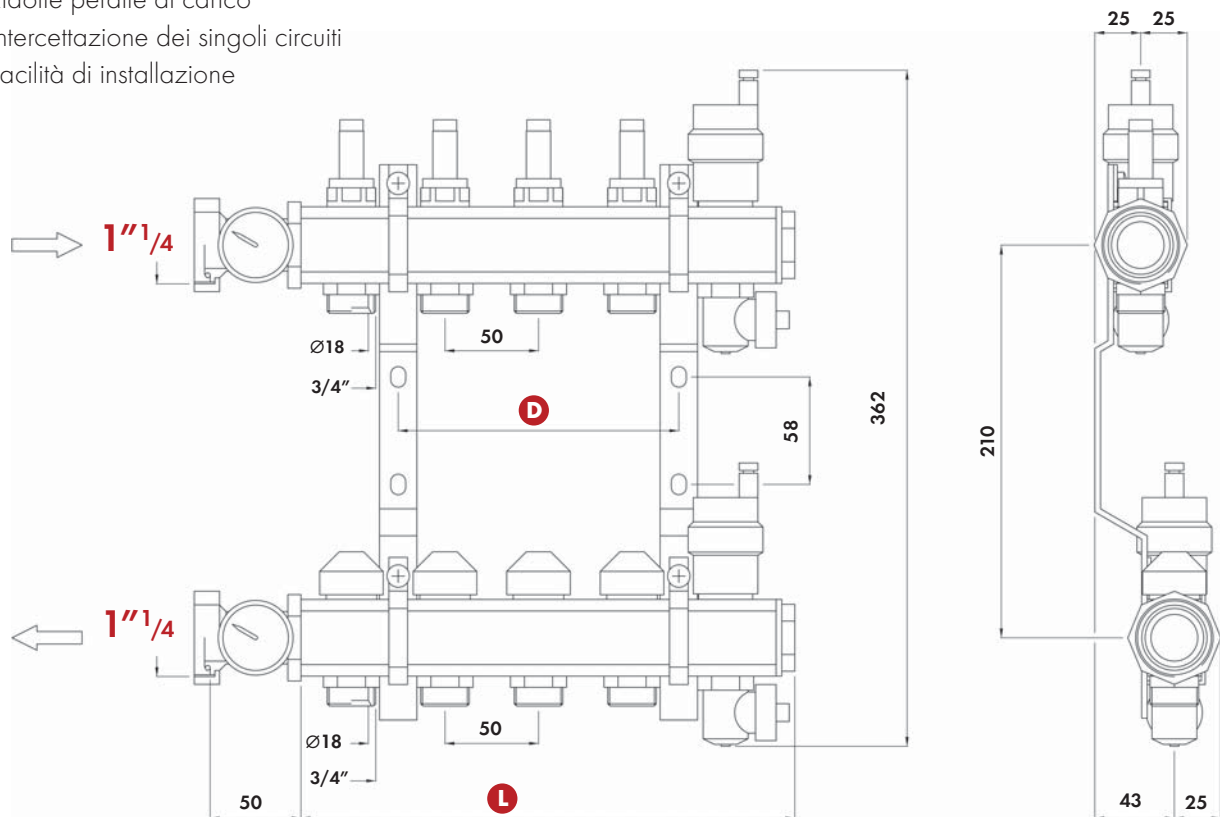

DIMENSIONI ED INGOMBRI

CODICE COLLETORE	N. USCITE	L (mm)	D (mm)	CODICE CASSETTA
88.10.140	2	164	50	88.10.315
88.10.141	3	214	100	88.10.315
88.10.142	4	264	150	88.10.315
88.10.143	5	314	200	88.10.315
88.10.144	6	364	250	88.10.320
88.10.145	7	414	300	88.10.320
88.10.146	8	464	350	88.10.320
88.10.147	9	514	400	88.10.320
88.10.148	10	564	450	88.10.325
88.10.149	11	614	500	88.10.325
88.10.150	12	664	550	88.10.325
88.10.151	13	714	600	88.10.325

COLLETTORE PRE-ASSEMBLATO DI DISTRIBUZIONE PER IMPIANTI DI RISCALDAMENTO

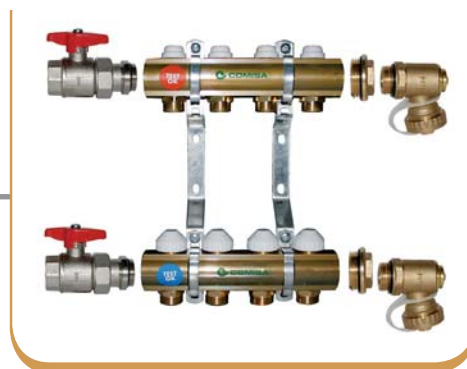

CODICE
88.10.500/510

Consente:

1. Precisione nel controllo e nella regolazione della portata dei singoli circuiti
2. Ridotte perdite di carico
3. Intercettazione dei singoli circuiti
4. Intercettazione dei flussi nei collettori di mandata e/o di ritorno
5. Facilità di installazione

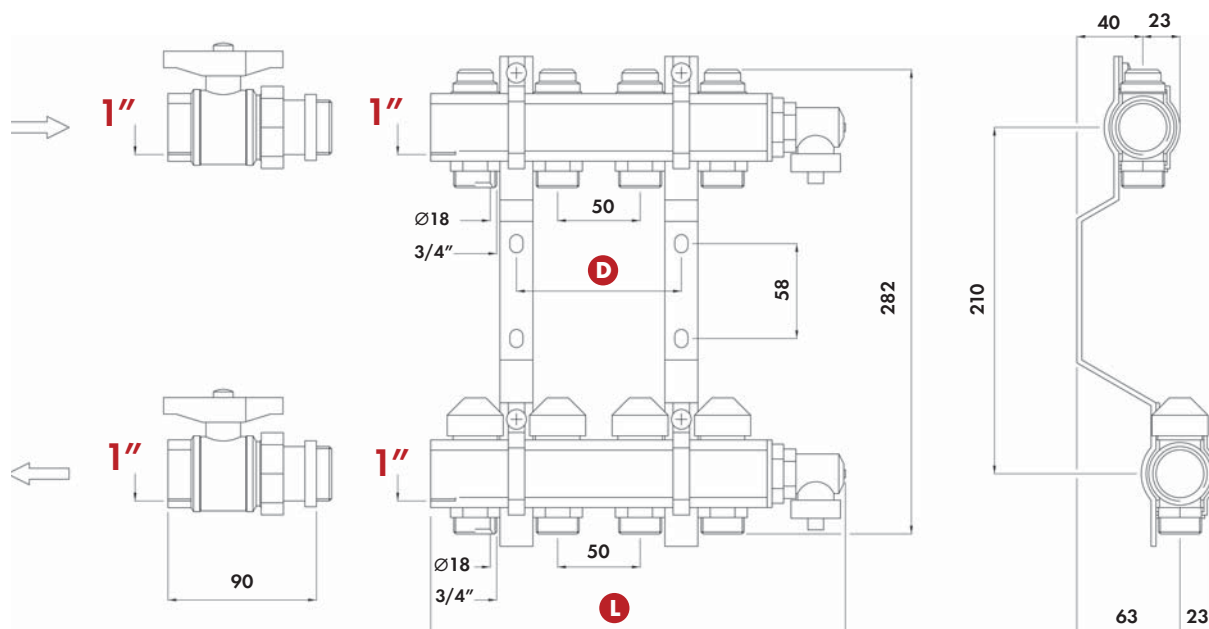

CODICE	N. USCITE	L (mm)	D (mm)	ART. CASSETTA
88.10.500	2	152	–	88.10.315
88.10.501	3	202	50	88.10.315
88.10.502	4	252	100	88.10.315
88.10.503	5	302	150	88.10.315
88.10.504	6	352	200	88.10.315
88.10.505	7	402	250	88.10.315
88.10.506	8	452	300	88.10.315
88.10.507	9	502	350	88.10.320
88.10.508	10	552	400	88.10.320
88.10.509	11	602	450	88.10.320
88.10.510	12	652	500	88.10.325



CODICE
88.10.511/521

COLLETTORE PRE-ASSEMBLATO DI DISTRIBUZIONE PER IMPIANTI DI RISCALDAMENTO

Consente:

1. Precisione nel controllo e nella regolazione della portata dei singoli circuiti
2. Facilità ed immediatezza nel monitoraggio della portata dei singoli circuiti
3. Ridotte perdite di carico
4. Intercettazione dei singoli circuiti
5. Intercettazione dei flussi nei collettori di mandata e/o di ritorno
4. Facilità di installazione

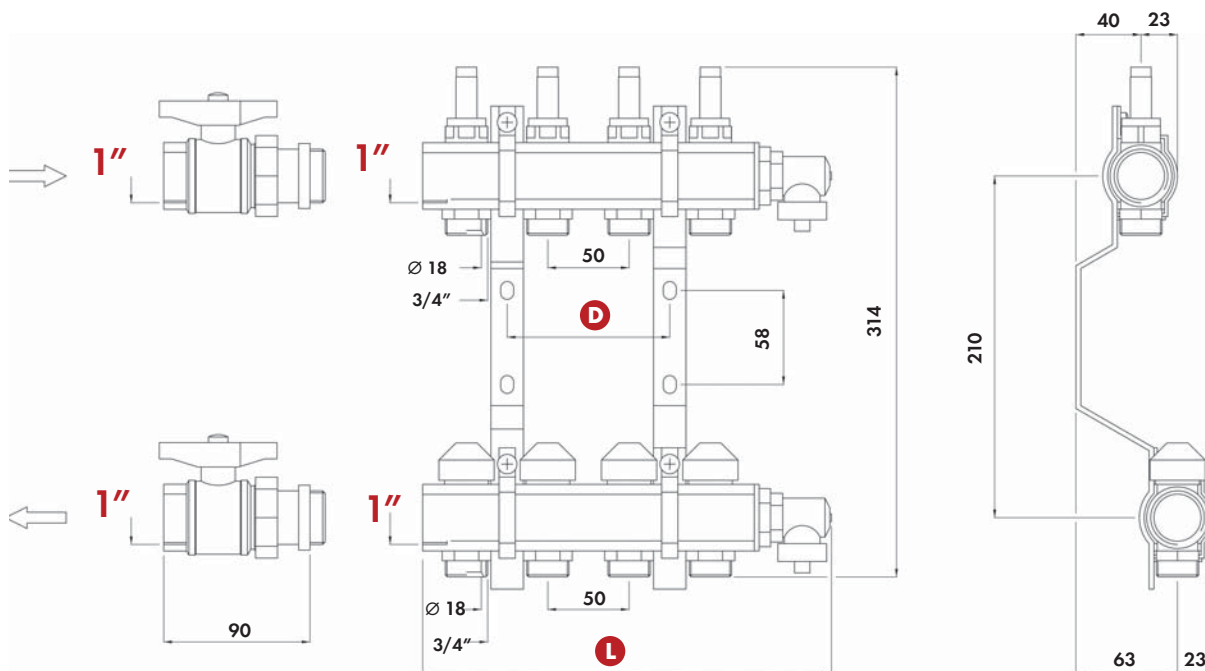

DIMENSIONI ED INGOMBRI

CODICE COLLETTORE	N. USCITE	L (mm)	D (mm)	CODICE CASSETTA
88.10.511	2	152	–	88.10.315
88.10.512	3	202	50	88.10.315
88.10.513	4	252	100	88.10.315
88.10.514	5	302	150	88.10.315
88.10.515	6	352	200	88.10.315
88.10.516	7	402	250	88.10.315
88.10.517	8	452	300	88.10.315
88.10.518	9	502	350	88.10.320
88.10.519	10	552	400	88.10.320
88.10.520	11	602	450	88.10.320
88.10.521	12	652	500	88.10.325

COLLETTORE PRE-ASSEMBLATO DI DISTRIBUZIONE PER IMPIANTI DI RISCALDAMENTO

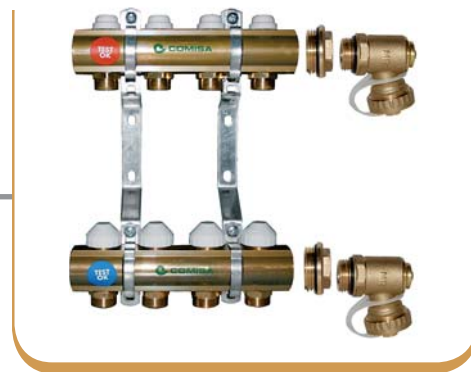

CODICE
88.10.522/532

Consente:

1. Precisione nel controllo e nella regolazione della portata dei singoli circuiti
2. Ridotte perdite di carico
3. Intercettazione dei singoli circuiti
4. Facilità di installazione

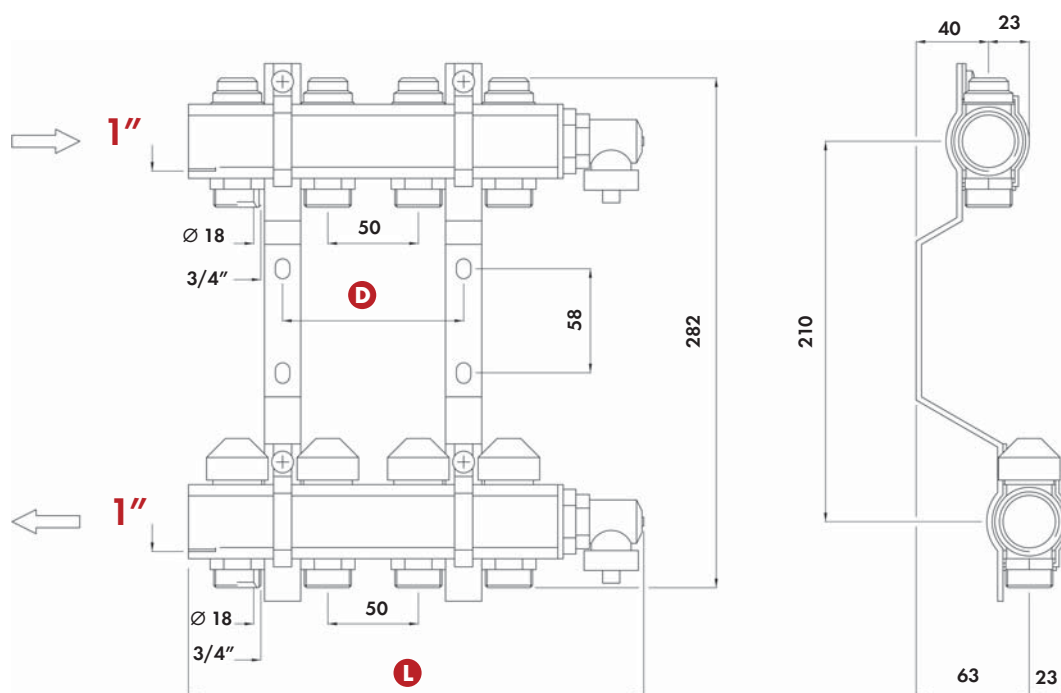

CODICE COLLETTORE	N. USCITE	L (mm)	D (mm)	CODICE CASSETTA
88.10.522	2	152	–	88.10.315
88.10.523	3	202	50	88.10.315
88.10.524	4	252	100	88.10.315
88.10.525	5	302	150	88.10.315
88.10.526	6	352	200	88.10.315
88.10.527	7	402	250	88.10.315
88.10.528	8	452	300	88.10.315
88.10.529	9	502	350	88.10.320
88.10.530	10	552	400	88.10.320
88.10.531	11	602	450	88.10.320
88.10.532	12	652	500	88.10.325



CODICE
88.10.533/543

COLLETORE PRE-ASSEMBLATO DI DISTRIBUZIONE PER IMPIANTI DI RISCALDAMENTO

Consente:

1. Precisione nel controllo e nella regolazione della portata dei singoli circuiti
2. Facilità ed immediatezza nel monitoraggio della portata dei singoli collettori
3. Ridotte perdite di carico
4. Intercettazione dei singoli circuiti
5. Facilità di installazione

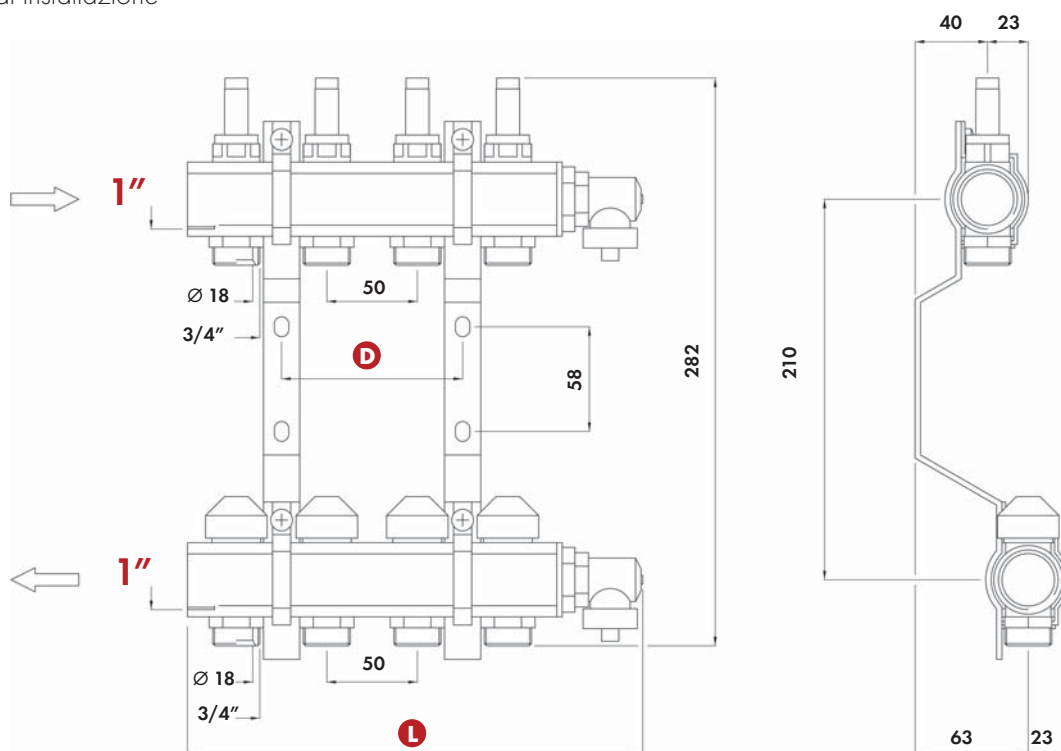

DIMENSIONI ED INGOMBRI

CODICE COLLETORE	N. USCITE	L (mm)	D (mm)	CODICE CASSETTA
88.10.533	2	152	–	88.10.315
88.10.534	3	202	50	88.10.315
88.10.535	4	252	100	88.10.315
88.10.536	5	302	150	88.10.315
88.10.537	6	352	200	88.10.315
88.10.538	7	402	250	88.10.315
88.10.539	8	452	300	88.10.315
88.10.540	9	502	350	88.10.320
88.10.541	10	552	400	88.10.320
88.10.542	11	602	450	88.10.320
88.10.543	12	652	500	88.10.325



COLLETORE PRE-ASSEMBLATO DI DISTRIBUZIONE PER IMPIANTI DI RISCALDAMENTO

CODICE

88.10.572/582

Consente:

1. Precisione nel controllo e nella regolazione della portata dei singoli circuiti
2. Facilità ed immediatezza nel monitoraggio della portata dei singoli circuiti
4. Ridotte perdite di carico
4. Intercettazione dei singoli circuiti
5. Facilità di installazione

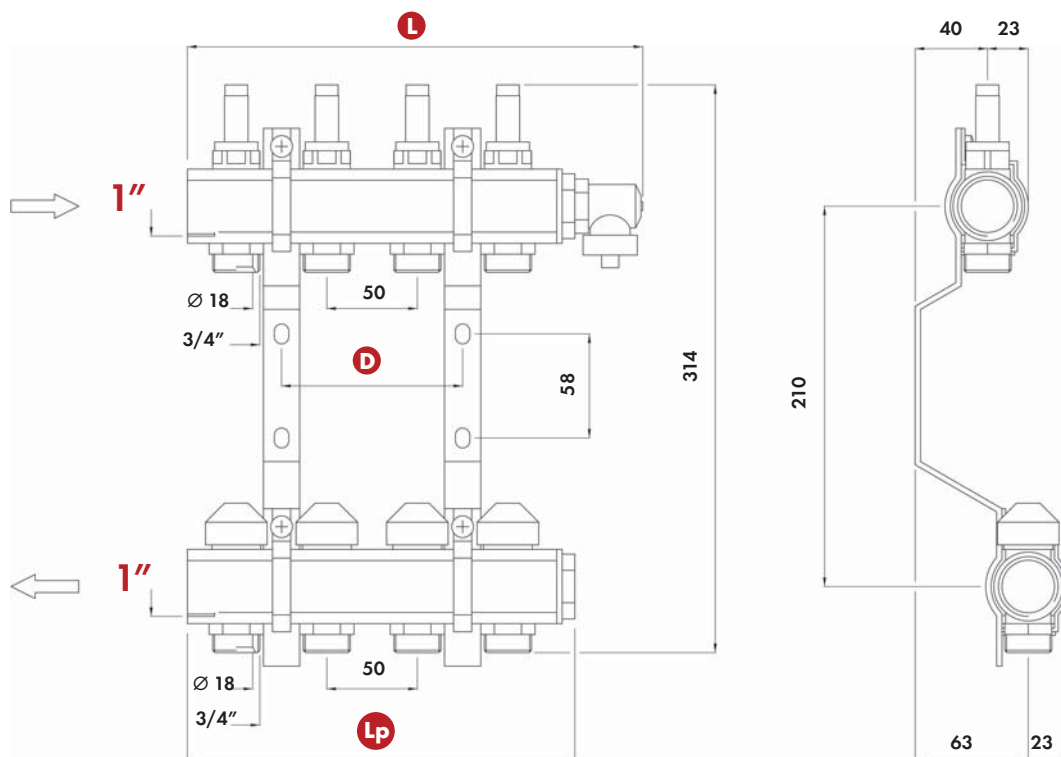

DIMENSIONI ED INGOMBRI

CODICE COLLETORE	N. USCITE	L (mm)	Lp (mm)	D (mm)	CODICE CASSETTA
88.10.572	2	152	114	–	88.10.315
88.10.573	3	202	164	50	88.10.315
88.10.574	4	252	54	100	88.10.315
88.10.575	5	302	264	150	88.10.315
88.10.576	6	352	314	200	88.10.315
88.10.577	7	402	364	250	88.10.315
88.10.578	8	452	414	300	88.10.315
88.10.579	9	502	464	350	88.10.320
88.10.580	10	552	514	400	88.10.320
88.10.581	11	602	564	450	88.10.320
88.10.582	12	652	614	500	88.10.325



CODICE
88.20.356/366

Consente:

1. Ridotte perdite di carico
2. Facilità di installazione

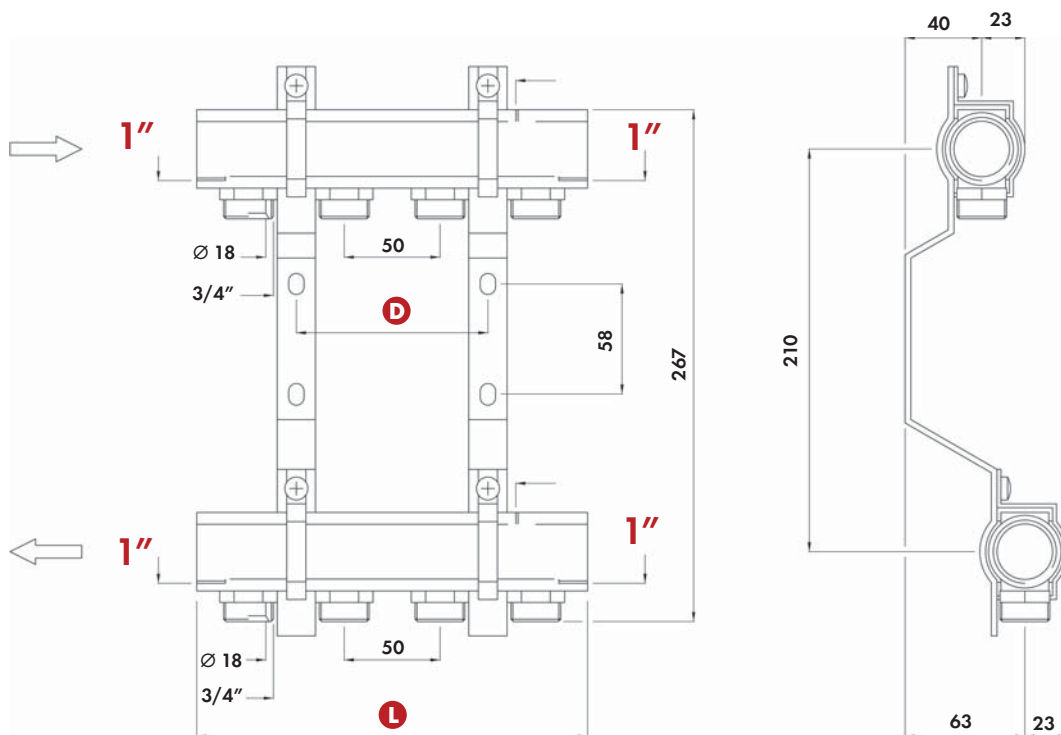

DIMENSIONI ED INGOMBRI

CODICE COLLETTORE	N. USCITE	L (mm)	D (mm)	CODICE CASSETTA
88.20.356	2	104	—	88.10.315
88.20.357	3	154	50	88.10.315
88.20.358	4	204	100	88.10.315
88.20.359	5	254	150	88.10.315
88.20.360	6	304	200	88.10.315
88.20.361	7	354	250	88.10.315
88.20.362	8	404	300	88.10.320
88.20.363	9	454	350	88.10.320
88.20.364	10	504	400	88.10.320
88.20.365	11	554	450	88.10.325
88.20.366	12	604	500	88.10.325

COLLETTORE PRE-ASSEMBLATO DI DISTRIBUZIONE PER IMPIANTI DI RISCALDAMENTO



CODICE

88.20.367/377

Consente:

1. Precisione nel controllo e nella regolazione della portata dei singoli circuiti
2. Ridotte perdite di carico
3. Intercettazione dei singoli circuiti
4. Facilità di installazione

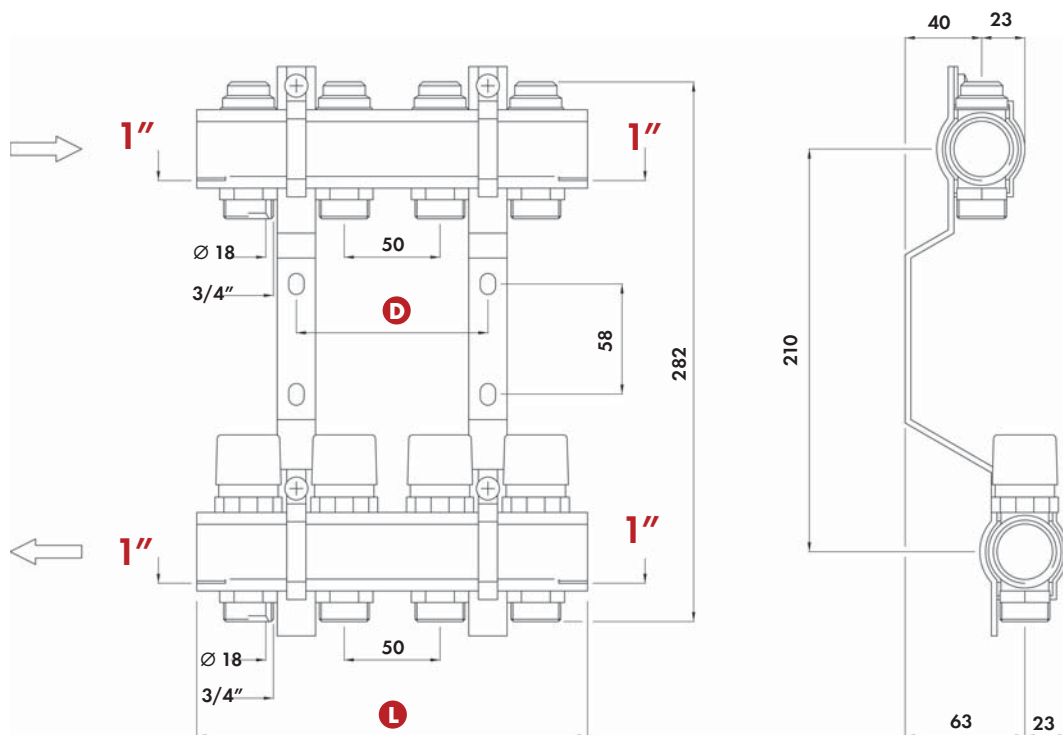

DIMENSIONI ED INGOMBRI

CODICE COLLETTORE	N. USCITE	L (mm)	D (mm)	CODICE CASSETTA
88.20.367	2	104	-	88.10.315
88.20.368	3	154	50	88.10.315
88.20.369	4	204	100	88.10.315
88.20.370	5	254	150	88.10.315
88.20.371	6	304	200	88.10.315
88.20.372	7	354	250	88.10.315
88.20.373	8	404	300	88.10.320
88.20.374	9	454	350	88.10.320
88.20.375	10	504	400	88.10.320
88.20.376	11	554	450	88.10.325
88.20.377	12	604	500	88.10.325

COLLETTORE PRE-ASSEMBLATO DI DISTRIBUZIONE PER IMPIANTI DI RISCALDAMENTO

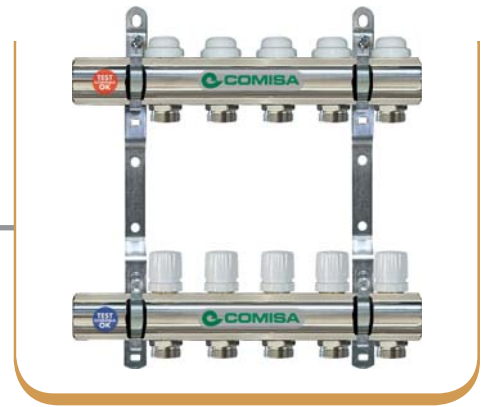

CODICE
88.20.378/388

Consente:

1. Precisione nel controllo e nella regolazione della portata dei singoli circuiti
2. Ridotte perdite di carico
3. Intercettazione dei singoli circuiti
4. Facilità di installazione

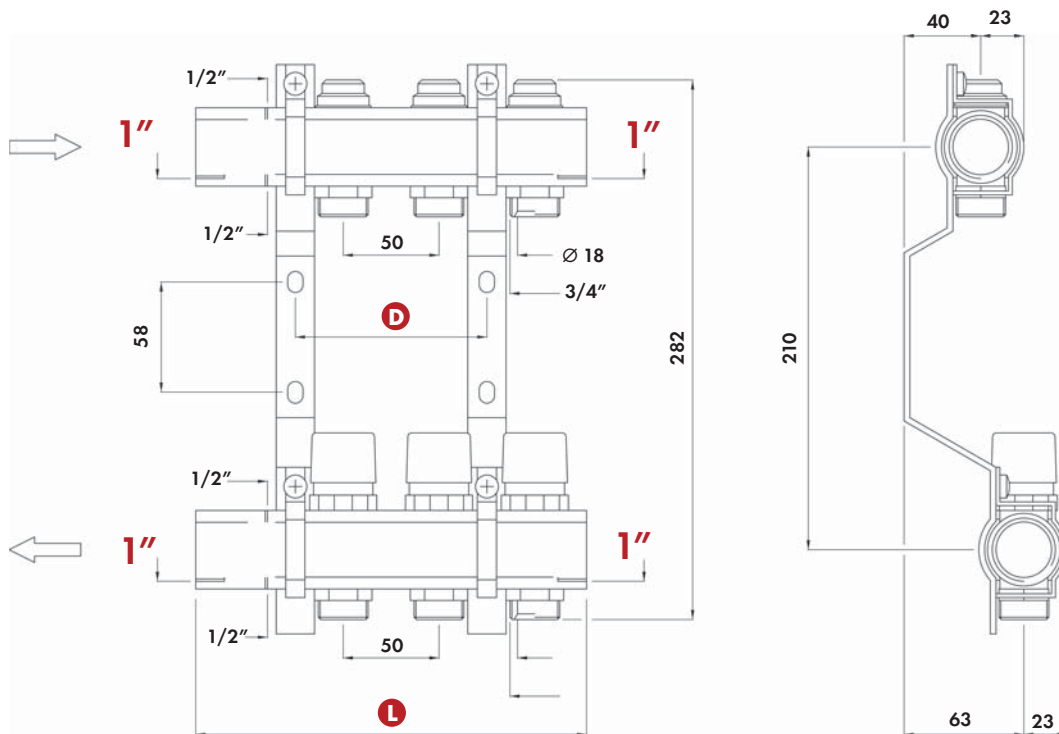

DIMENSIONI ED INGOMBRI

CODICE COLLETTORE	N. USCITE	L (mm)	D (mm)	CODICE CASSETTA
88.20.378	2	104	50	88.10.315
88.20.379	3	154	100	88.10.315
88.20.380	4	204	150	88.10.315
88.20.381	5	254	200	88.10.315
88.20.382	6	304	250	88.10.315
88.20.383	7	354	300	88.10.315
88.20.384	8	404	350	88.10.320
88.20.385	9	454	400	88.10.320
88.20.386	10	504	450	88.10.320
88.20.387	11	554	500	88.10.325
88.20.388	12	604	550	88.10.325

COLLETTORE PRE-ASSEMBLATO DI DISTRIBUZIONE PER IMPIANTI DI RISCALDAMENTO



CODICE
88.20.400/410

Consente:

1. Precisione nel controllo e nella regolazione della portata dei singoli circuiti
2. Ridotte perdite di carico
3. Intercettazione dei singoli circuiti
4. Facilità di installazione

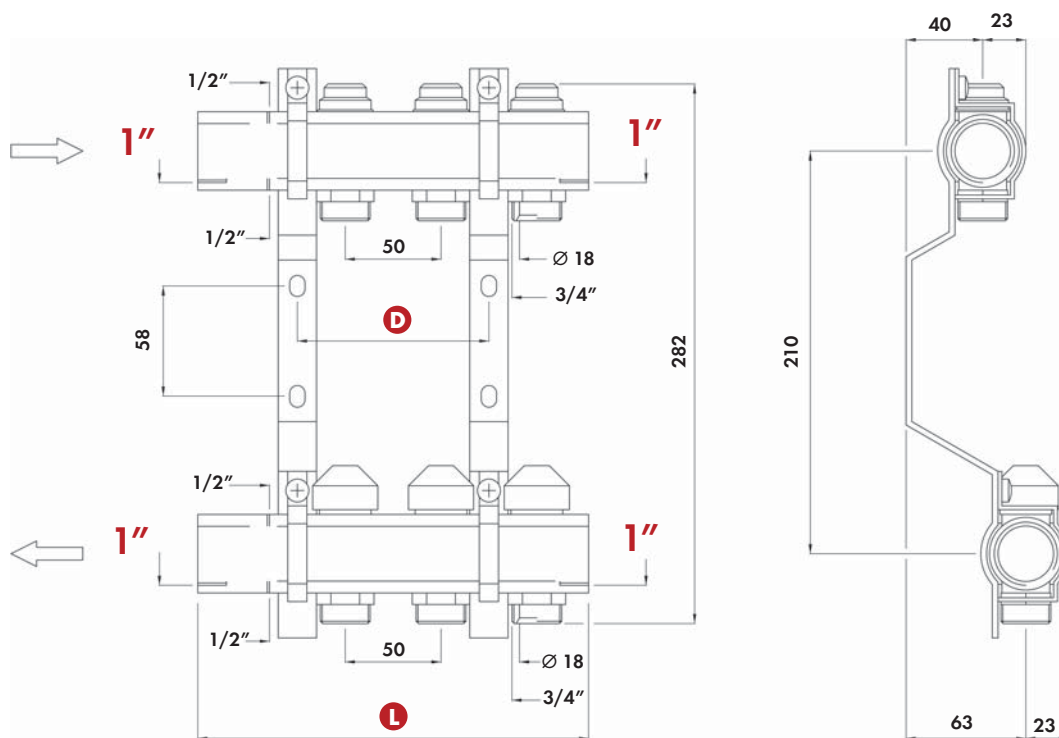

DIMENSIONI ED INGOMBRI

CODICE COLLETTORE	N. USCITE	L (mm)	D (mm)	CODICE CASSETTA
88.20.400	2	104	–	88.10.315
88.20.401	3	154	50	88.10.315
88.20.402	4	204	100	88.10.315
88.20.403	5	254	150	88.10.315
88.20.404	6	304	200	88.10.315
88.20.405	7	354	250	88.10.315
88.20.406	8	404	300	88.10.320
88.20.407	9	454	350	88.10.320
88.20.408	10	504	400	88.10.320
88.20.409	11	554	450	88.10.325
88.20.410	12	604	500	88.10.325



CODICE
88.20.411/421

Consente:

1. Precisione nel controllo e nella regolazione della portata dei singoli circuiti
2. Facilità ed immediatezza nel monitoraggio della portata dei singoli circuiti
3. Ridotte perdite di carico
4. Intercettazione dei singoli circuiti
5. Facilità di installazione

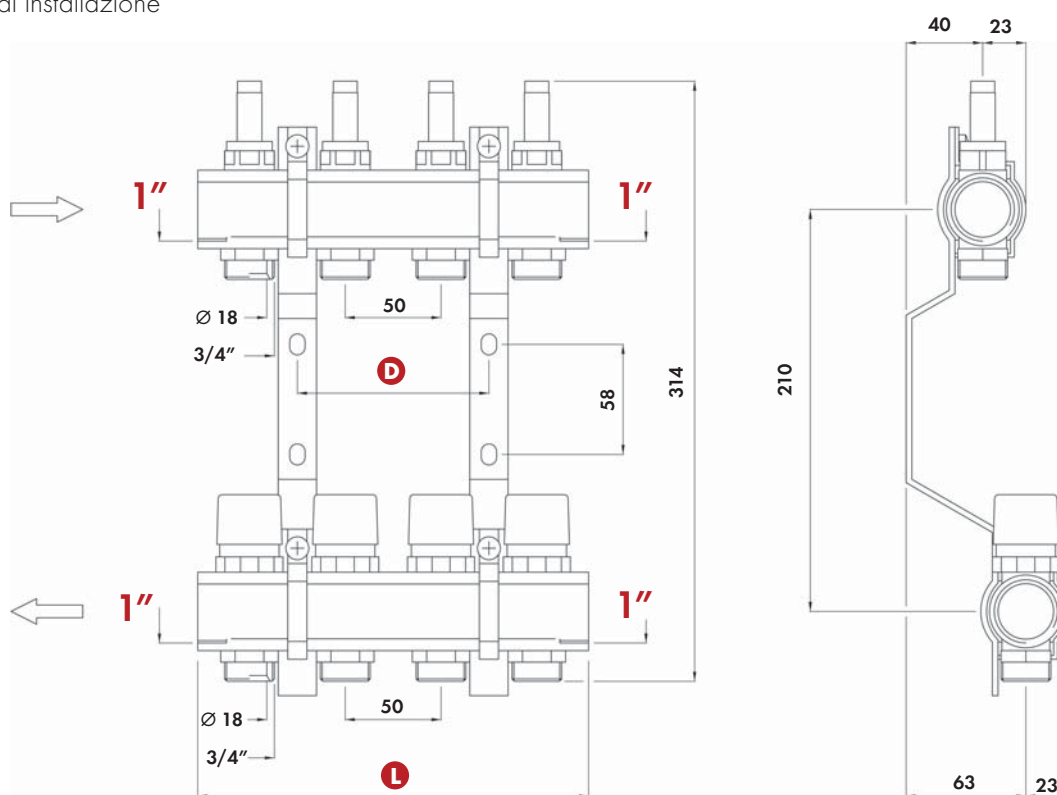

DIMENSIONI ED INGOMBRI

CODICE COLLETTORE	N. USCITE	L (mm)	D (mm)	CODICE CASSETTA
88.20.411	2	104	–	88.10.315
88.20.412	3	154	50	88.10.315
88.20.413	4	204	100	88.10.315
88.20.414	5	254	150	88.10.315
88.20.415	6	304	200	88.10.315
88.20.416	7	354	250	88.10.315
88.20.417	8	404	300	88.10.320
88.20.418	9	454	350	88.10.320
88.20.419	10	504	400	88.10.320
88.20.420	11	554	450	88.10.325
88.20.421	12	604	500	88.10.325

COLLETTORE PRE-ASSEMBLATO DI DISTRIBUZIONE PER IMPIANTI DI RISCALDAMENTO

Consente:

1. Precisione nel controllo e nella regolazione della portata dei singoli circuiti
2. Facilità ed immediatezza nel monitoraggio della portata dei singoli circuiti
3. Ridotte perdite di carico
4. Intercettazione dei singoli circuiti
5. Facilità di installazione

CODICE
88.20.422/432

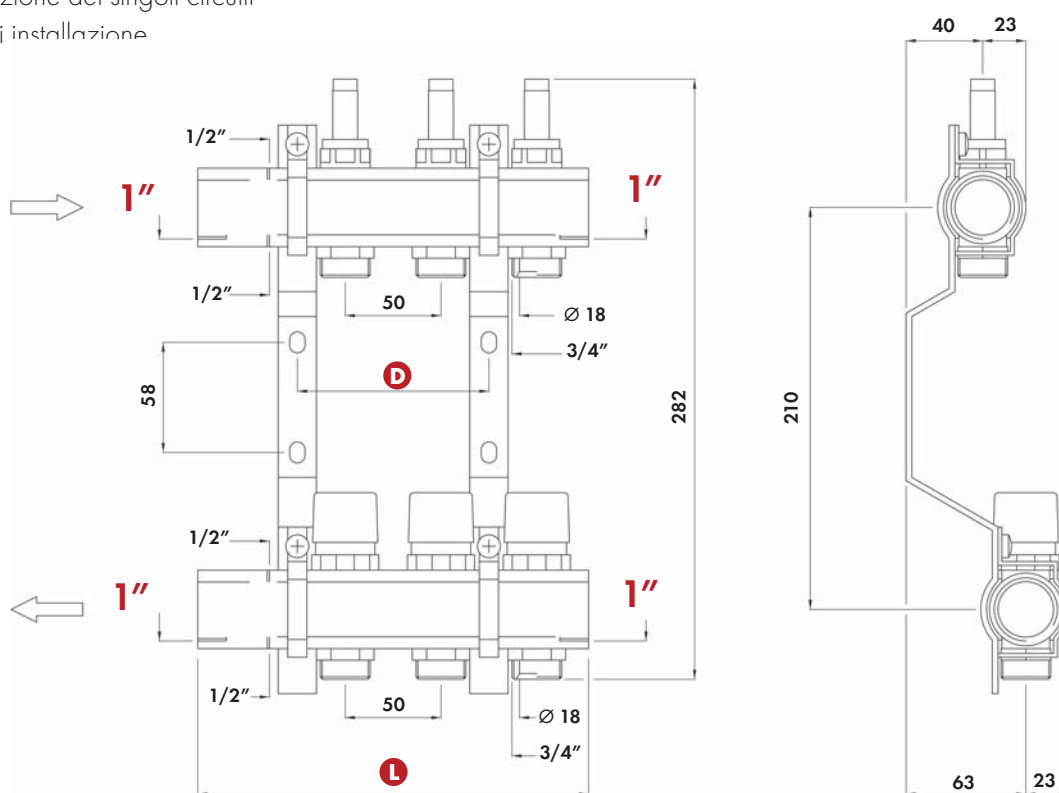

DIMENSIONI ED INGOMBRI

CODICE COLLETTORE	N. USCITE	L (mm)	D (mm)	CODICE CASSETTA
88.20.422	2	104	50	88.10.315
88.20.423	3	154	100	88.10.315
88.20.424	4	204	150	88.10.315
88.20.425	5	254	200	88.10.315
88.20.426	6	304	250	88.10.315
88.20.427	7	354	300	88.10.315
88.20.428	8	404	350	88.10.320
88.20.429	9	454	400	88.10.320
88.20.430	10	504	450	88.10.320
88.20.431	11	554	500	88.10.325
88.20.432	12	604	550	88.10.325



CODICE

88.20.433/443

Consente:

1. Precisione nel controllo e nella regolazione della portata dei singoli circuiti
2. Intercettazione dei flussi nei collettori di mandata e/o di ritorno
3. Ridotte perdite di carico
4. Intercettazione dei singoli circuiti
5. Facilità di installazione

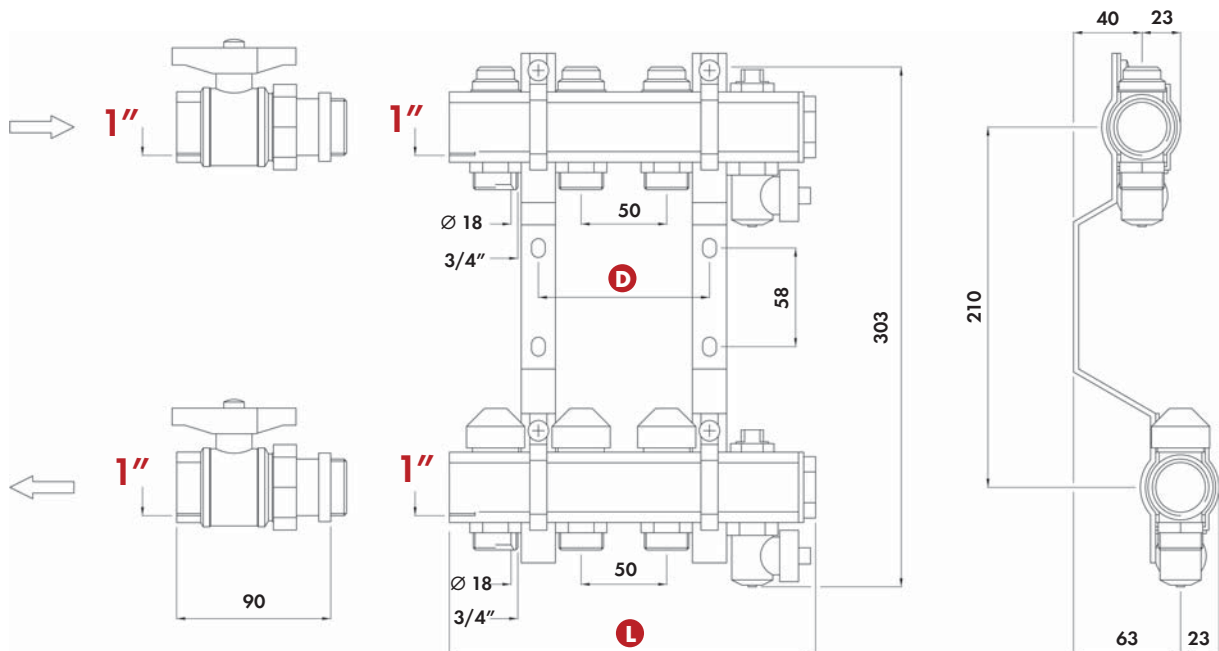

DIMENSIONI ED INGOMBRI

CODICE COLLETTORE	N. USCITE	L (mm)	D (mm)	CODICE CASSETTA
88.20.433	2	114	–	88.10.315
88.20.434	3	164	50	88.10.315
88.20.435	4	214	100	88.10.315
88.20.436	5	264	150	88.10.315
88.20.437	6	314	200	88.10.315
88.20.438	7	364	250	88.10.315
88.20.439	8	414	300	88.10.320
88.20.440	9	464	350	88.10.320
88.20.441	10	514	400	88.10.320
88.20.442	11	564	450	88.10.325
88.20.443	12	614	500	88.10.325

COLLETTORE PRE-ASSEMBLATO DI DISTRIBUZIONE PER IMPIANTI DI RISCALDAMENTO

Consente:

1. Precisione nel controllo e nella regolazione della portata dei singoli circuiti
2. Facilità ed immediatezza nel monitoraggio della portata dei singoli circuiti
3. Ridotte perdite di carico
4. Intercettazione dei singoli circuiti
5. Intercettazione dei flussi nei collettori di mandata e/o di ritorno
6. Facilità di installazione



CODICE

88.20.444/454

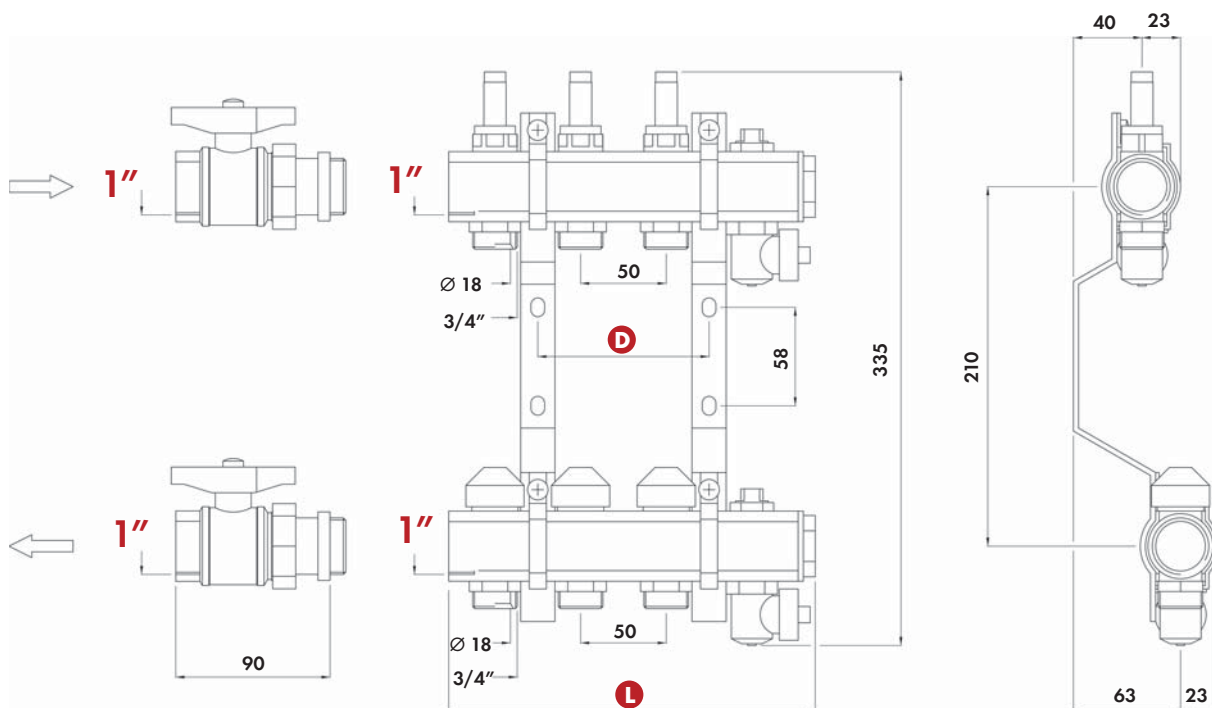

DIMENSIONI ED INGOMBRI

CODICE COLLETTORE	N. USCITE	L (mm)	D (mm)	CODICE CASSETTA
88.20.444	2	114	–	88.10.315
88.20.445	3	164	50	88.10.315
88.20.446	4	214	100	88.10.315
88.20.447	5	264	150	88.10.315
88.20.448	6	314	200	88.10.315
88.20.449	7	364	250	88.10.315
88.20.450	8	414	300	88.10.320
88.20.451	9	464	350	88.10.320
88.20.452	10	514	400	88.10.320
88.20.453	11	564	450	88.10.325
88.20.454	12	614	500	88.10.325

SCHEDA TECNICHE

COLLETTORE DI RITORNO

COLLETTORE DI MANDATA
CON **DETENTORI**

COLLETTORE DI MANDATA
CON **FLUSSOMETRI**

PRESTAZIONI

FLUIDI AMMESSI	ACQUA, SOLUZIONI GLICOLATE
% GLICOLE MAX	30%
PRESSIONE MAX	10 BAR
TEMPERATURA MAX	90° C
TEMPERATURA DI ESERCIZIO	80° C

Kv REGOLAZIONE

N. GIRI	3
Kv	3,46

PERDITE DI CARICO COLLETTORE DI RITORNO

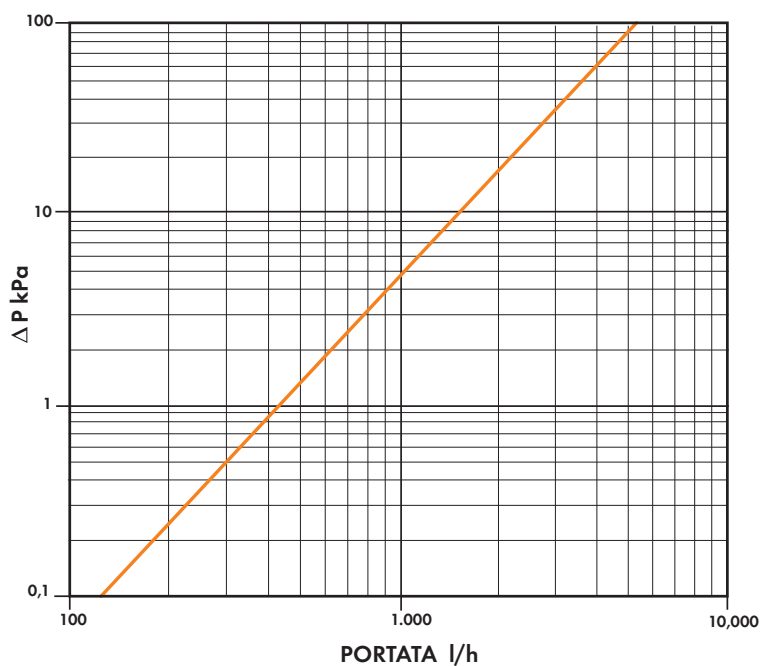

PIANTONE TERMOSTATIZZABILE

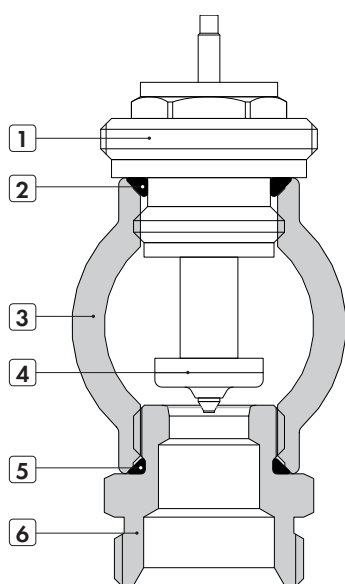

MATERIALE COLLETTORE DI RITORNO

1	CORPO	OTTONE CW 617N
2	O-RING	EPDM 70 SH
3	CORPO COLLETTORE	OTTONE CW 617N
4	OTTURATORE	EPDM 70 SH
5	O-RING	EPDM 70 SH
6	RACCORDO 3/4"	OTTONE CW 617N

Collettore di mandata con detentori

CARATTERISTICHE TECNICHE

PRESTAZIONI

FLUIDI AMMESSI	ACQUA, SOLUZIONI GLICOLATE
% GLICOLE MAX	30%
PRESSIONE MAX	10 BAR
TEMPERATURA MAX	90° C
TEMPERATURA DI ESERCIZIO	80° C

REGOLAZIONE (N. GIRI DALLA POSIZIONE OTTURATORE COMPLETAMENTE CHIUSO)

N. GIRI	0,5	1,5	2,25	2,75	3,5	5	6,25	7	7,5	8	TA
Kv	0,13	0,28	0,48	0,6	0,97	1,15	1,3	1,45	1,59	1,69	1,77

PERDITE DI CARICO DETENTORE

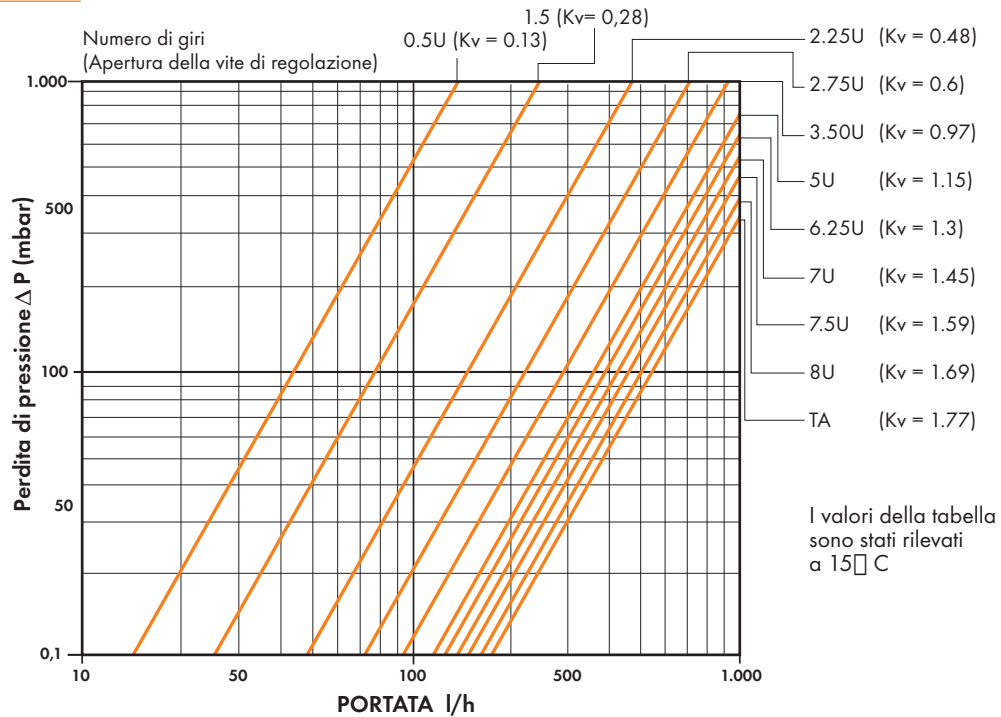

DETTENTORE

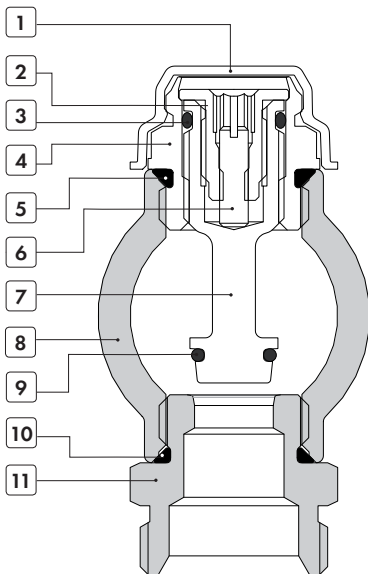

MATERIALI COLLETTORE DI MANDATA CON DETENTORI

1	CAPPUCCIO	POLIPROPILENE
2	CORPO DETENTORE	NYLON 12
3	O-RING	EPDM 70 SH
4	CORPO DETENTORE	OTTONE CW 617 N
5	O-RING	EPDM 70 SH
6	GRANO	OTTONE CW 617 N
7	OTTURATORE	OTTONE CW 617 N
8	CORPO COLLETTORE	OTTONE CW 617 N
9	O-RING	EPDM 70 SH
10	O-RING	EPDM 70 SH
11	RACCORDO 3/4"	OTTONE CW 617 N

Collettore di mandata con FLUSSOMETRI

CARATTERISTICHE TECNICHE

PRESTAZIONI

FLUIDI AMMESSI	ACQUA, SOLUZIONI GLICOLATE
% GLICOLE MAX	30%
PRESSIONE MAX	10 BAR
TEMPERATURA MAX	90° C
TEMPERATURA DI ESERCIZIO	80° C
CAMPO DI MISURA	da 0 a 6 Lit./min.
COEFFICIENTE DI PORTATA MAX	Kvs = 1.8
ERRORE DI INDICAZIONE	± 10% f.s. ovvero ± 0.6 Lit/min
ΔP DI FUNZIONAMENTO	La differenza di pressione ai capi del flussometro può variare da 10kPa (1.45 PSI) fino ad un massimo di 50 kPa (7.25 PSI) per ottenere la lettura con errore max del 10% del fondo scala
TRAFILAMENTO MAX	<= 0.02% Kvs con otturatore chiuso
COPPIA DI SERRAGGIO Flussometro SUL COLLETTORE	30 Nm
CONSIGLIATA IN CASO DI SOSTITUZIONE	

PERDITE DI CARICO FLUSSOMETRO

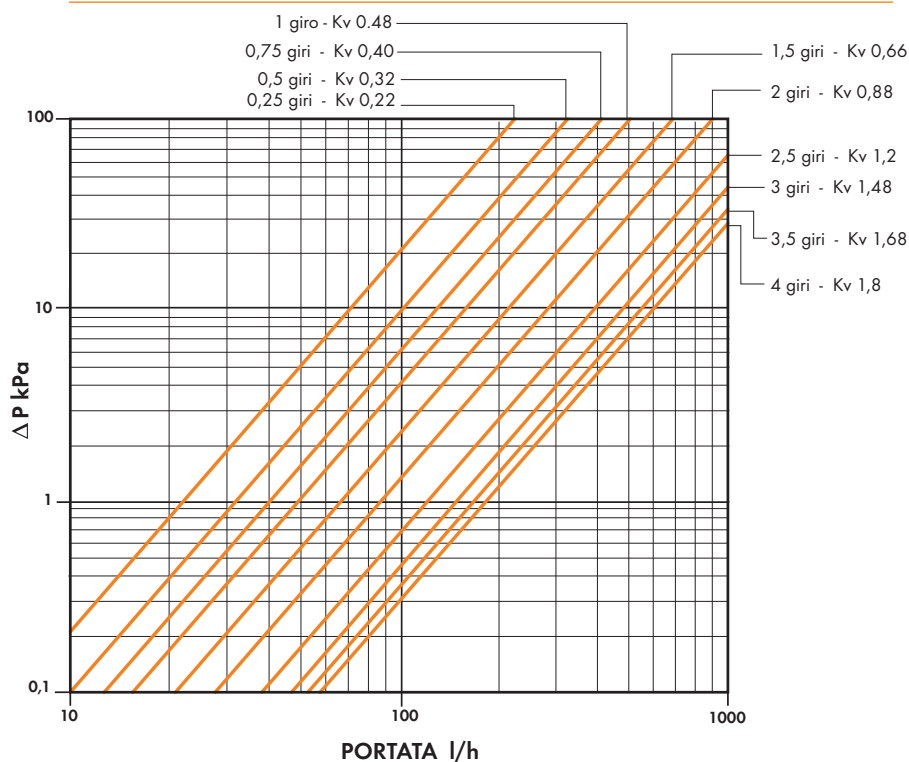

FLUSSOMETRO

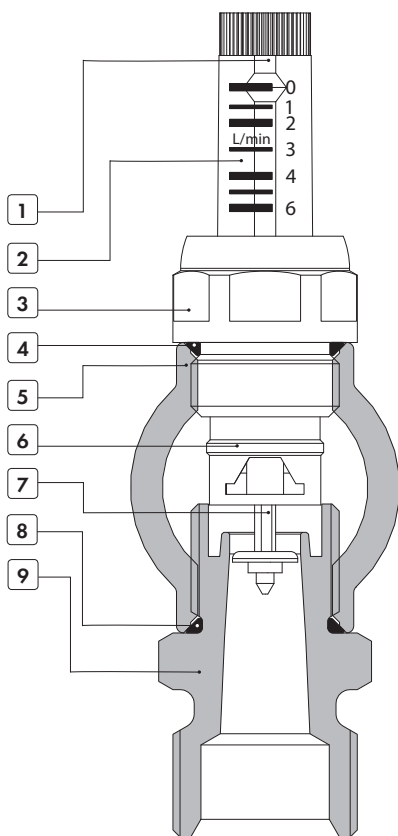

MATERIALI COLLETTORE DI MANDATA CON FLUSSOMETRO

1	INDICATORE DI LIVELLO	NYLON 12
2	TUBO GRADUATO	NYLON 12
3	CORPO	OTTONE CW 617 N
4	O-RING	EPDM 70 SH
5	CORPO COLLETTORE	OTTONE CW 617 N
6	OTTURATORE	NYLON 12
7	ASTA DI LIVELLO	NYLON 12
8	O-RING	EPDM 70 SH
9	RACCORDO 3/4"	OTTONE CW 617 N



MANIFOLDS

FOR UNDERFLOOR COOLING AND HEATING SYSTEMS,
TRADITIONAL HEATING AND SANITARY WARE

PREASSEMBLED DISTRIBUTION MANIFOLD FOR HEATING SYSTEM

Allows:

1. Accuracy when controlling and regulating the flow rate of the single circuits
2. Controlling the temperature of the outlet and inlet manifolds
3. Low friction loss
4. Shutting single circuits
5. Easy to install



CODE
88.10.120/130

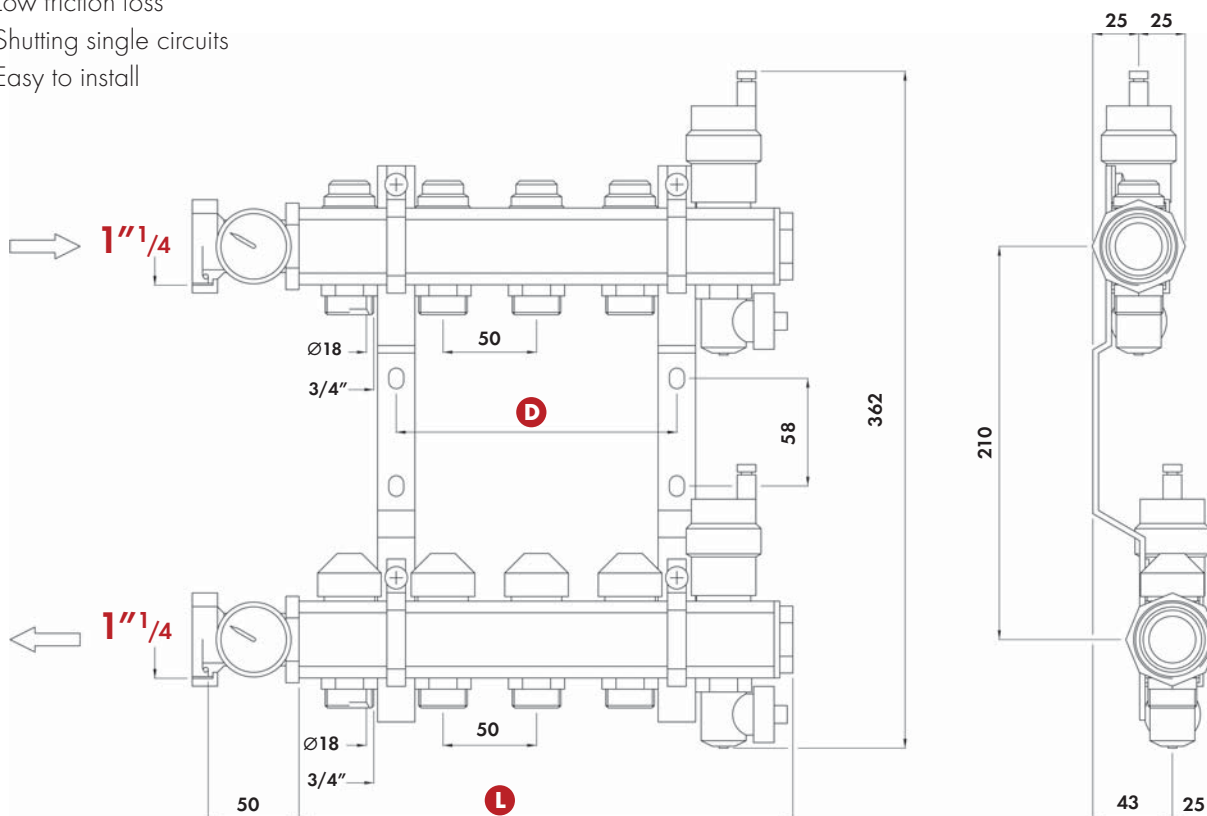

OVERALL DIMENSIONS

MANIFOLD CODE	N° OF OUTLETS	L (mm)	D (mm)	CABINET CODE
88.10.120	2	164	50	88.10.315
88.10.121	3	214	100	88.10.315
88.10.122	4	264	150	88.10.315
88.10.123	5	314	200	88.10.315
88.10.124	6	364	250	88.10.320
88.10.125	7	414	300	88.10.320
88.10.126	8	464	350	88.10.320
88.10.127	9	514	400	88.10.320
88.10.128	10	564	450	88.10.325
88.10.129	11	614	500	88.10.325
88.10.130	12	664	550	88.10.325

PREASSEMBLED DISTRIBUTION MANIFOLD FOR HEATING SYSTEM

Allows:

1. Accuracy when controlling and regulating the flow rate of the single circuits
2. Easy and instantaneous monitoring of the flow rate of the single circuits
3. Controlling the temperature of the outlet and inlet manifolds
4. Low friction loss
5. Shutting single circuits
6. Easy to install



CODE
88.10.140/150

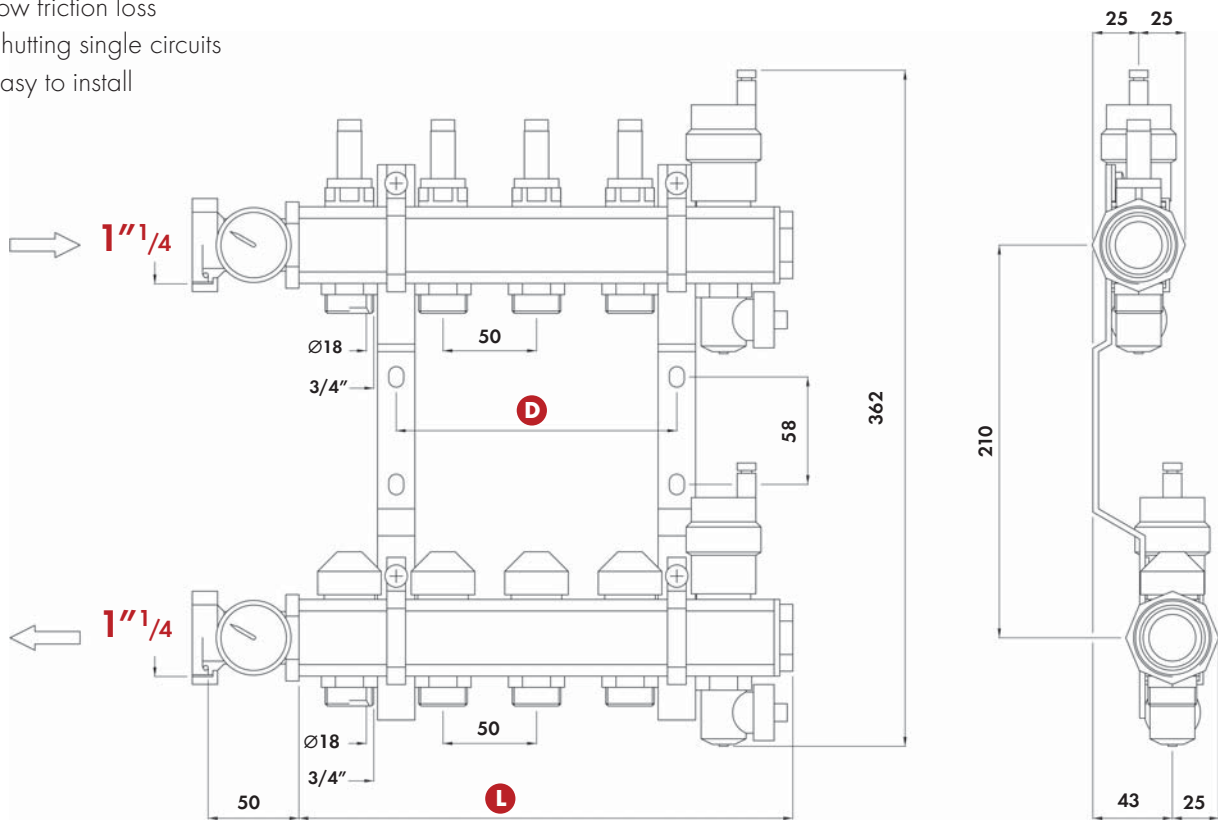

OVERALL DIMENSIONS

MANIFOLD CODE	N° OF OUTLETS	L (mm)	D (mm)	CABINET CODE
88.10.140	2	164	50	88.10.315
88.10.141	3	214	100	88.10.315
88.10.142	4	264	150	88.10.315
88.10.143	5	314	200	88.10.315
88.10.144	6	364	250	88.10.320
88.10.145	7	414	300	88.10.320
88.10.146	8	464	350	88.10.320
88.10.147	9	514	400	88.10.320
88.10.148	10	564	450	88.10.325
88.10.149	11	614	500	88.10.325
88.10.150	12	664	550	88.10.325
88.10.151	13	714	600	88.10.325

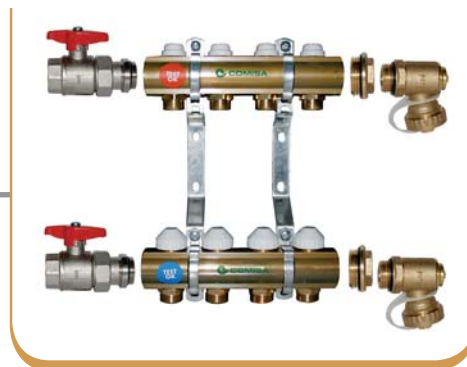

CODE
88.10.500/510

Allows:

1. Accuracy when controlling and regulating the flow rate of the single circuits
2. Low friction loss
3. Shutting single circuits
4. Shutting flows in outlet and/or inlet manifolds
5. Easy to install

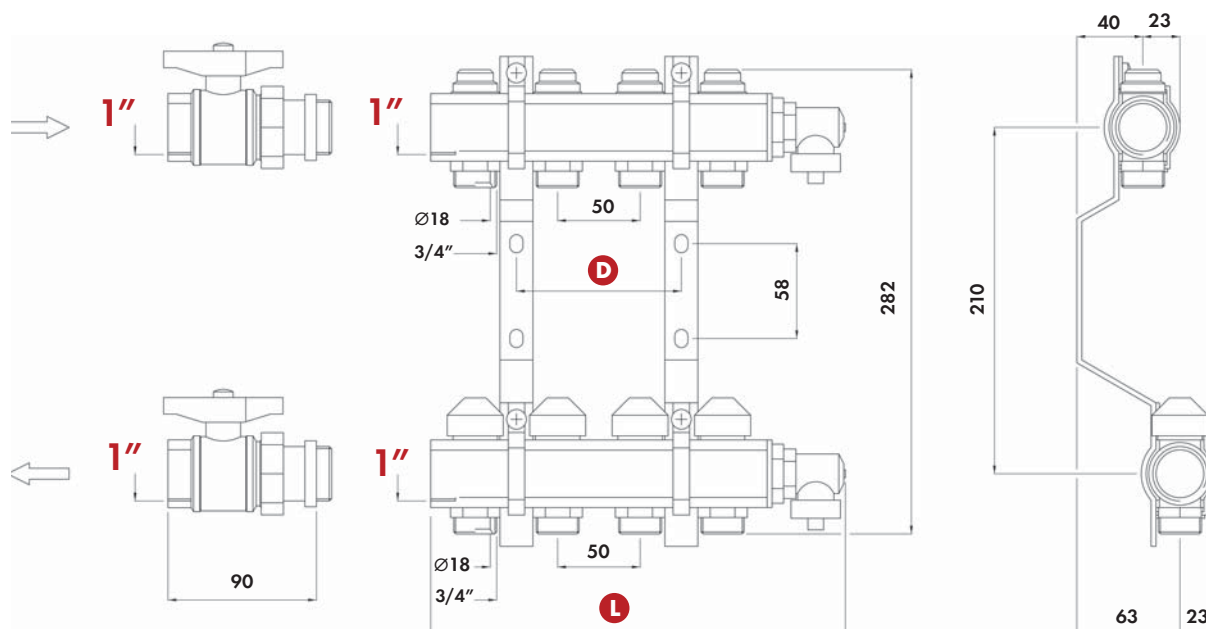

OVERALL DIMENSIONS

MANIFOLD CODE	N° OF OUTLETS	L (mm)	D (mm)	CABINET CODE
88.10.500	2	152	–	88.10.315
88.10.501	3	202	50	88.10.315
88.10.502	4	252	100	88.10.315
88.10.503	5	302	150	88.10.315
88.10.504	6	352	200	88.10.315
88.10.505	7	402	250	88.10.315
88.10.506	8	452	300	88.10.315
88.10.507	9	502	350	88.10.320
88.10.508	10	552	400	88.10.320
88.10.509	11	602	450	88.10.320
88.10.510	12	652	500	88.10.325

PREASSEMBLED DISTRIBUTION MANIFOLD FOR HEATING SYSTEM



CODE
88.10.511/521

Allows:

1. Accuracy when controlling and regulating the flow rate of the single circuits
2. Easy and instantaneous monitoring of the flow rate of the single circuits
3. Low friction loss
4. Shutting single circuits
5. Shutting flows in outlet and/or inlet manifolds

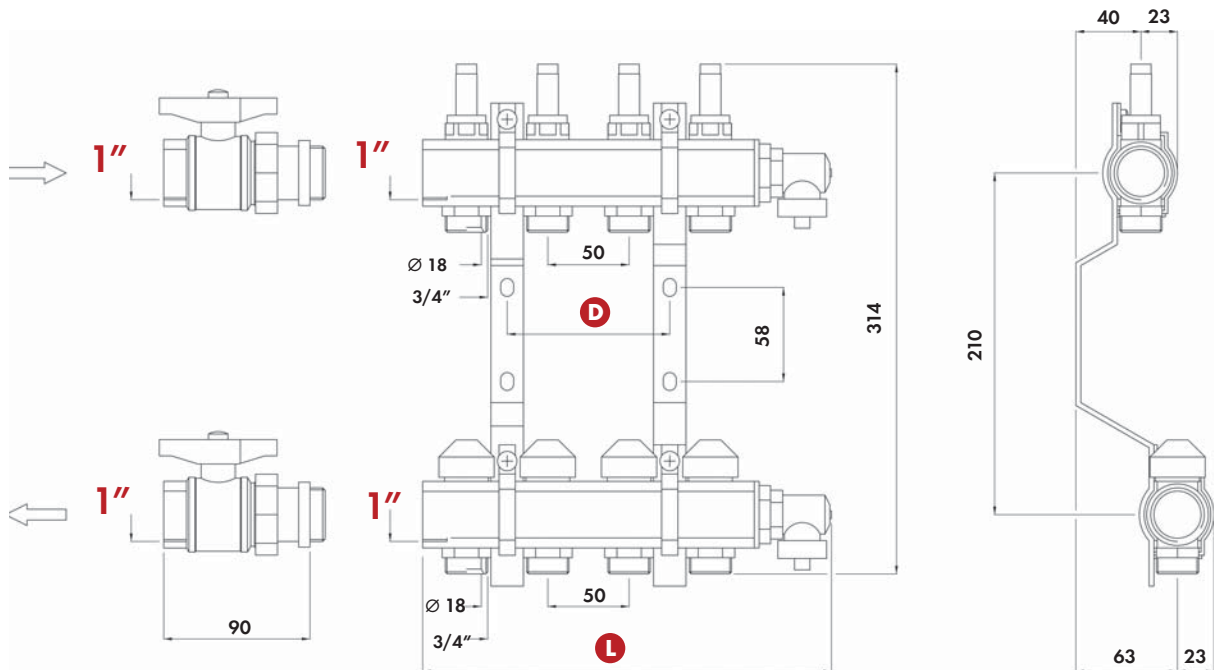

OVERALL DIMENSIONS

MANIFOLD CODE	N° OF OUTLETS	L (mm)	D (mm)	CABINET CODE
88.10.511	2	152	–	88.10.315
88.10.512	3	202	50	88.10.315
88.10.513	4	252	100	88.10.315
88.10.514	5	302	150	88.10.315
88.10.515	6	352	200	88.10.315
88.10.516	7	402	250	88.10.315
88.10.517	8	452	300	88.10.315
88.10.518	9	502	350	88.10.320
88.10.519	10	552	400	88.10.320
88.10.520	11	602	450	88.10.320
88.10.521	12	652	500	88.10.325

PREASSEMBLED DISTRIBUTION MANIFOLD FOR HEATING SYSTEM

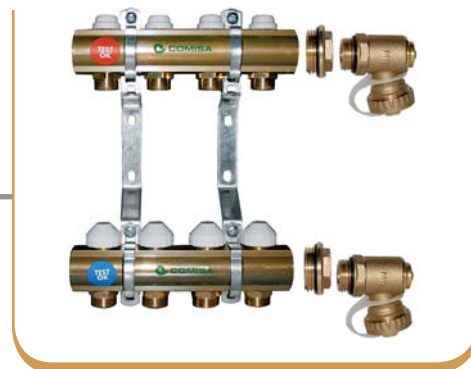

CODE
88.10.522/532

Allows:

1. Accuracy when controlling and regulating the flow rate of the single circuits
2. Low friction loss
3. Shutting single circuits
4. Easy to install

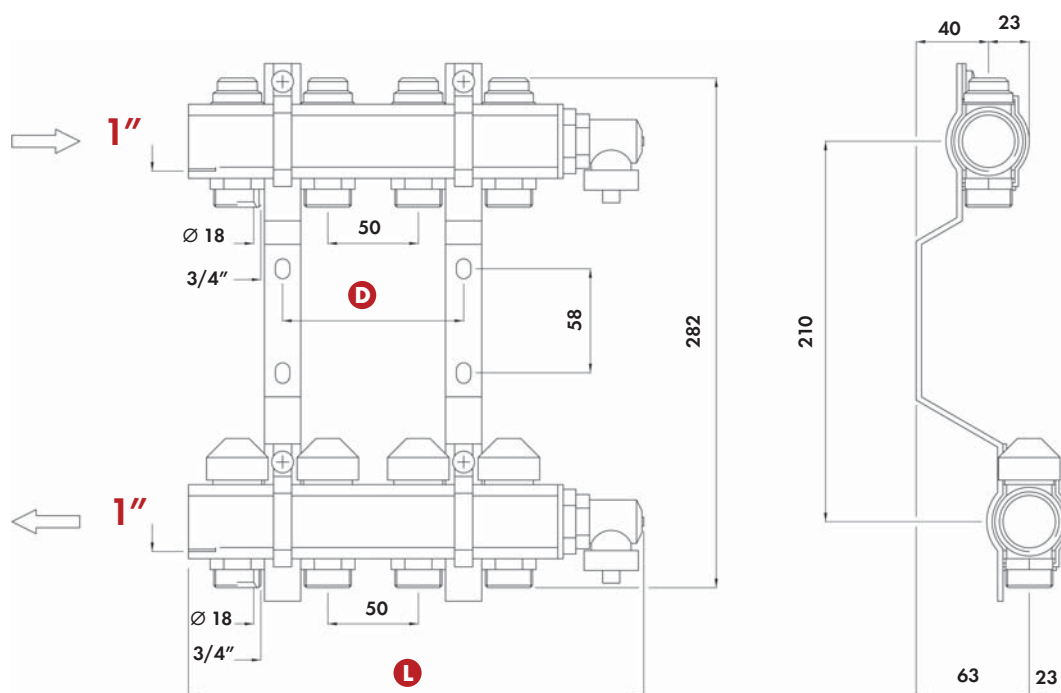

OVERALL DIMENSIONS

MANIFOLD CODE	N° OF OUTLETS	L (mm)	D (mm)	CABINET CODE
88.10.522	2	152	–	88.10.315
88.10.523	3	202	50	88.10.315
88.10.524	4	252	100	88.10.315
88.10.525	5	302	150	88.10.315
88.10.526	6	352	200	88.10.315
88.10.527	7	402	250	88.10.315
88.10.528	8	452	300	88.10.315
88.10.529	9	502	350	88.10.320
88.10.530	10	552	400	88.10.320
88.10.531	11	602	450	88.10.320
88.10.532	12	652	500	88.10.325



CODE
88.10.533/543

PREASSEMBLED DISTRIBUTION MANIFOLD FOR HEATING SYSTEM

Allows:

1. Accuracy when controlling and regulating the flow rate of the single circuits
2. Easy and instantaneous monitoring of the flow rate of the single circuits
3. Low friction loss
4. Shutting single circuits
5. Easy to install

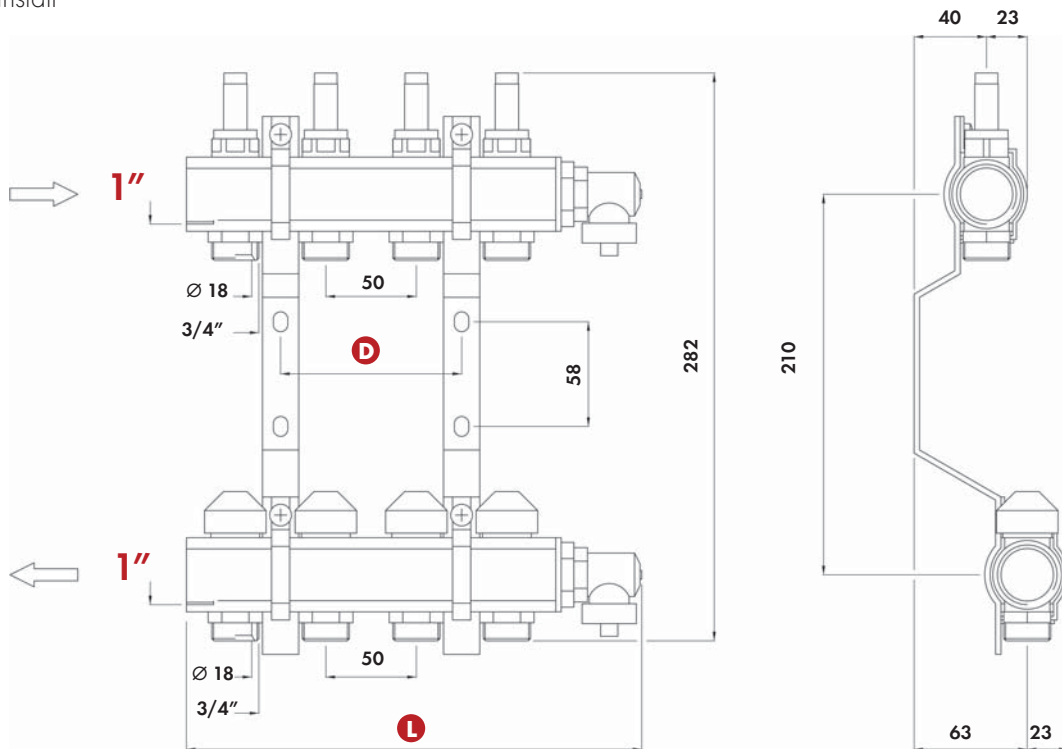

OVERALL DIMENSIONS

MANIFOLD CODE	N° OF OUTLETS	L (mm)	D (mm)	CABINET CODE
88.10.533	2	152	–	88.10.315
88.10.534	3	202	50	88.10.315
88.10.535	4	252	100	88.10.315
88.10.536	5	302	150	88.10.315
88.10.537	6	352	200	88.10.315
88.10.538	7	402	250	88.10.315
88.10.539	8	452	300	88.10.315
88.10.540	9	502	350	88.10.320
88.10.541	10	552	400	88.10.320
88.10.542	11	602	450	88.10.320
88.10.543	12	652	500	88.10.325

PREASSEMBLED DISTRIBUTION MANIFOLD FOR HEATING SYSTEM

Allows:

1. Accuracy when controlling and regulating the flow rate of the single circuits
2. Easy and instantaneous monitoring of the flow rate of the single circuits
3. Low friction loss
4. Shutting single circuits
5. Easy to install



CODE

88.10.572/582

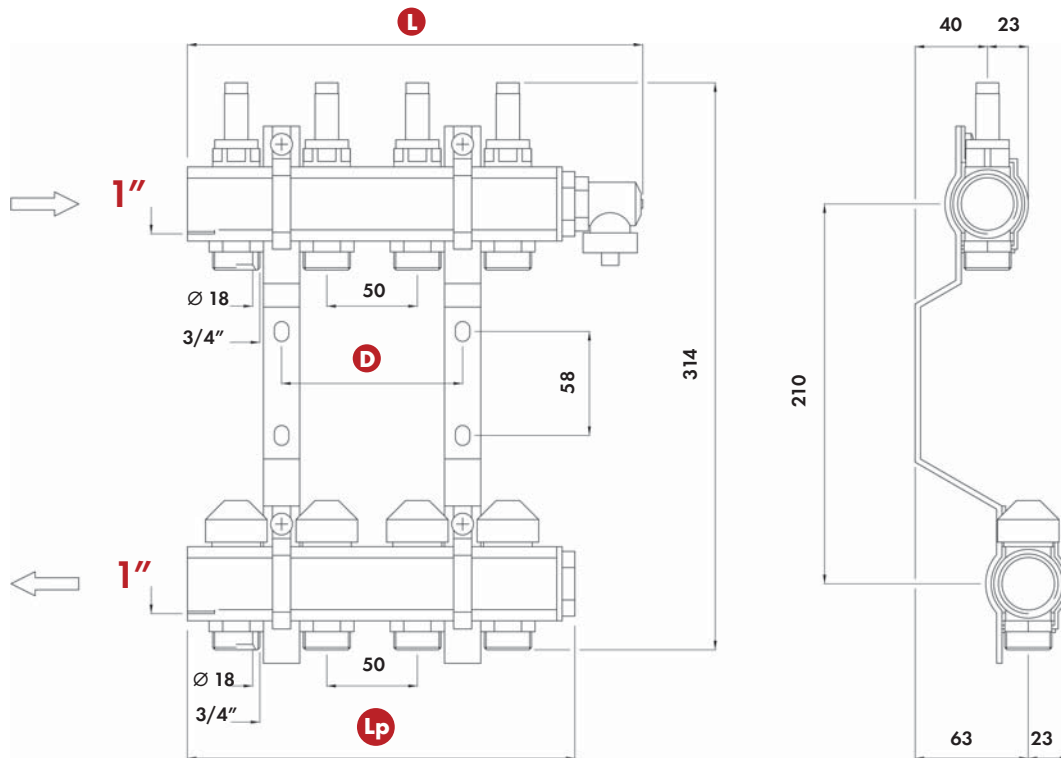

OVERALL DIMENSIONS

MANIFOLD CODE	N° OF OUTLETS	L (mm)	Lp (mm)	D (mm)	CABINET CODE
88.10.572	2	152	114	–	88.10.315
88.10.573	3	202	164	50	88.10.315
88.10.574	4	252	54	100	88.10.315
88.10.575	5	302	264	150	88.10.315
88.10.576	6	352	314	200	88.10.315
88.10.577	7	402	364	250	88.10.315
88.10.578	8	452	414	300	88.10.315
88.10.579	9	502	464	350	88.10.320
88.10.580	10	552	514	400	88.10.320
88.10.581	11	602	564	450	88.10.320
88.10.582	12	652	614	500	88.10.325

PREASSEMBLED DISTRIBUTION MANIFOLD FOR HEATING SYSTEM



CODE
88.20.356/366

Allows:

1. Low friction loss
2. Easy to install

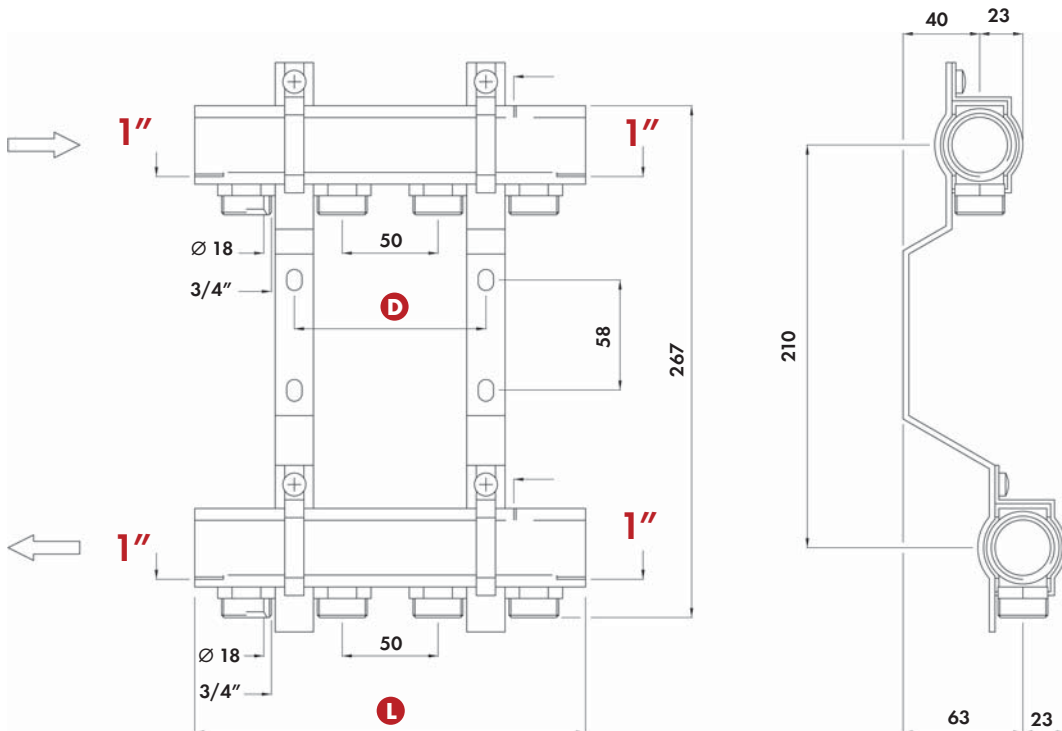

OVERALL DIMENSIONS

MANIFOLD CODE	N° OF OUTLETS	L (mm)	D (mm)	CABINET CODE
88.20.356	2	104	–	88.10.315
88.20.357	3	154	50	88.10.315
88.20.358	4	204	100	88.10.315
88.20.359	5	254	150	88.10.315
88.20.360	6	304	200	88.10.315
88.20.361	7	354	250	88.10.315
88.20.362	8	404	300	88.10.320
88.20.363	9	454	350	88.10.320
88.20.364	10	504	400	88.10.320
88.20.365	11	554	450	88.10.325
88.20.366	12	604	500	88.10.325

PREASSEMBLED DISTRIBUTION MANIFOLD FOR HEATING SYSTEM



CODE

88.20.367/377

Allows:

1. Accuracy when controlling and regulating the flow rate of the single circuits
2. Low friction loss
3. Shutting single circuits
4. Easy to install

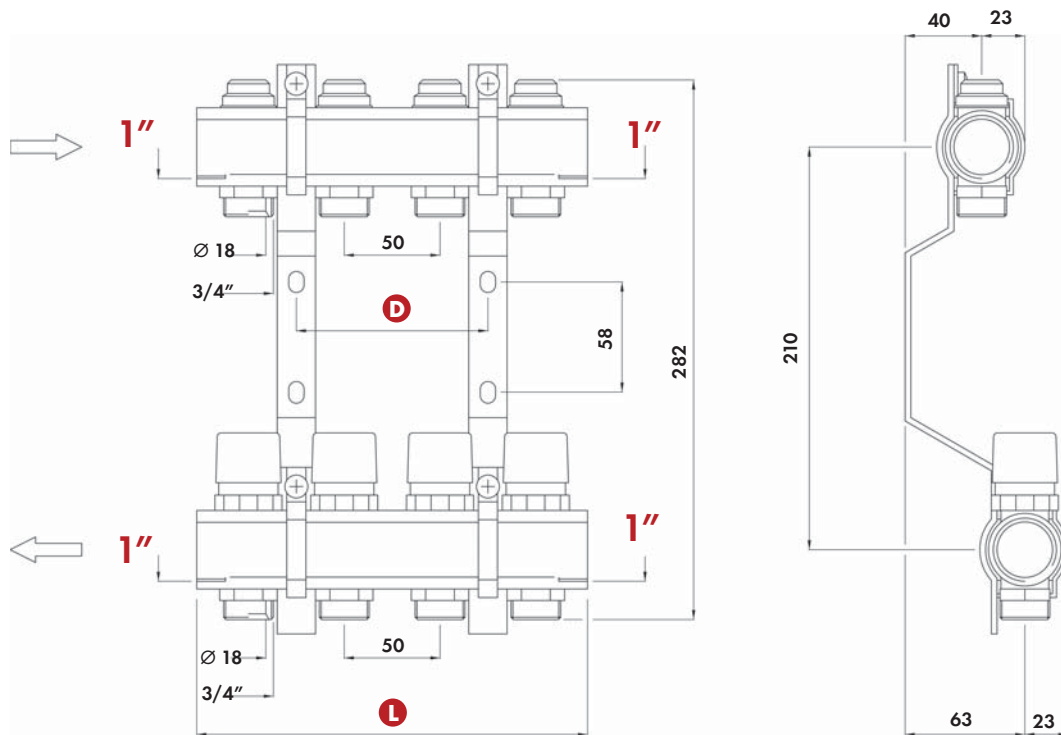

OVERALL DIMENSIONS

MANIFOLD CODE	N° OF OUTLETS	L (mm)	D (mm)	CABINET CODE
88.20.367	2	104	-	88.10.315
88.20.368	3	154	50	88.10.315
88.20.369	4	204	100	88.10.315
88.20.370	5	254	150	88.10.315
88.20.371	6	304	200	88.10.315
88.20.372	7	354	250	88.10.315
88.20.373	8	404	300	88.10.320
88.20.374	9	454	350	88.10.320
88.20.375	10	504	400	88.10.320
88.20.376	11	554	450	88.10.325
88.20.377	12	604	500	88.10.325

PREASSEMBLED DISTRIBUTION MANIFOLD FOR HEATING SYSTEM

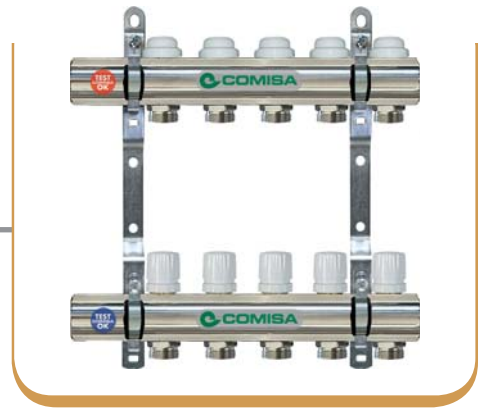

CODE
88.20.378/388

Allows:

1. Accuracy when controlling and regulating the flow rate of the single circuits
2. Low friction loss
3. Shutting single circuits
4. Easy to install

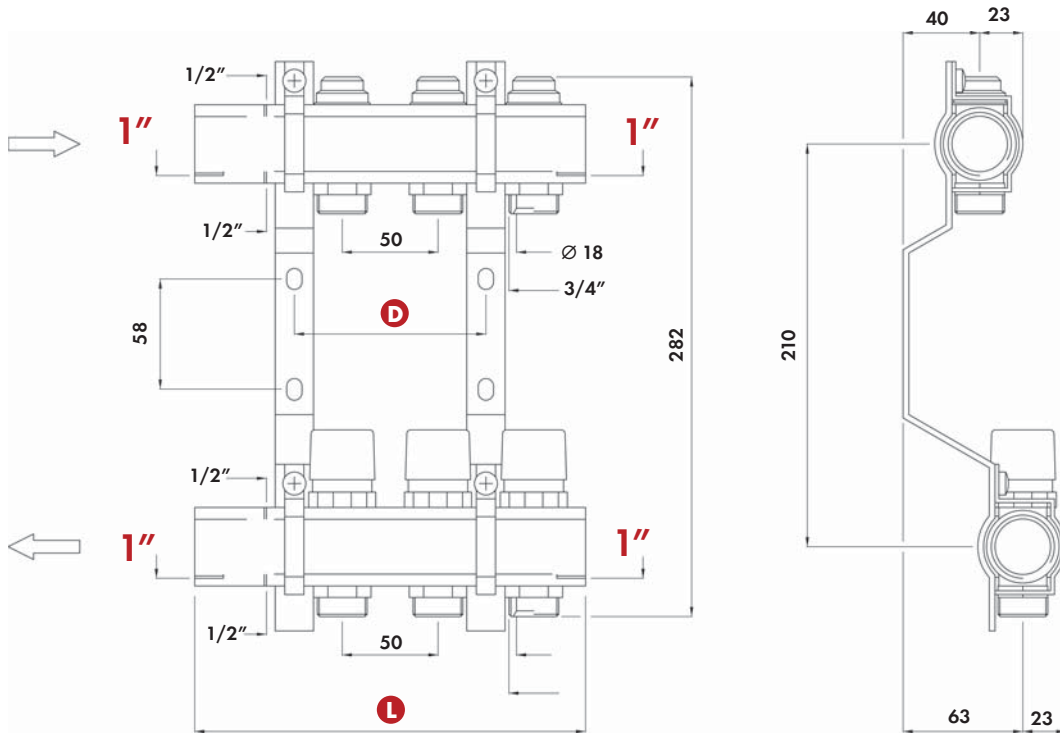

OVERALL DIMENSIONS

MANIFOLD CODE	N° OF OUTLETS	L (mm)	D (mm)	CABINET CODE
88.20.378	2	104	50	88.10.315
88.20.379	3	154	100	88.10.315
88.20.380	4	204	150	88.10.315
88.20.381	5	254	200	88.10.315
88.20.382	6	304	250	88.10.315
88.20.383	7	354	300	88.10.315
88.20.384	8	404	350	88.10.320
88.20.385	9	454	400	88.10.320
88.20.386	10	504	450	88.10.320
88.20.387	11	554	500	88.10.325
88.20.388	12	604	550	88.10.325

PREASSEMBLED DISTRIBUTION MANIFOLD FOR HEATING SYSTEM



CODE
88.20.400/410

Allows:

1. Accuracy when controlling and regulating the flow rate of the single circuits
2. Low friction loss
3. Shutting single circuits
4. Easy to install

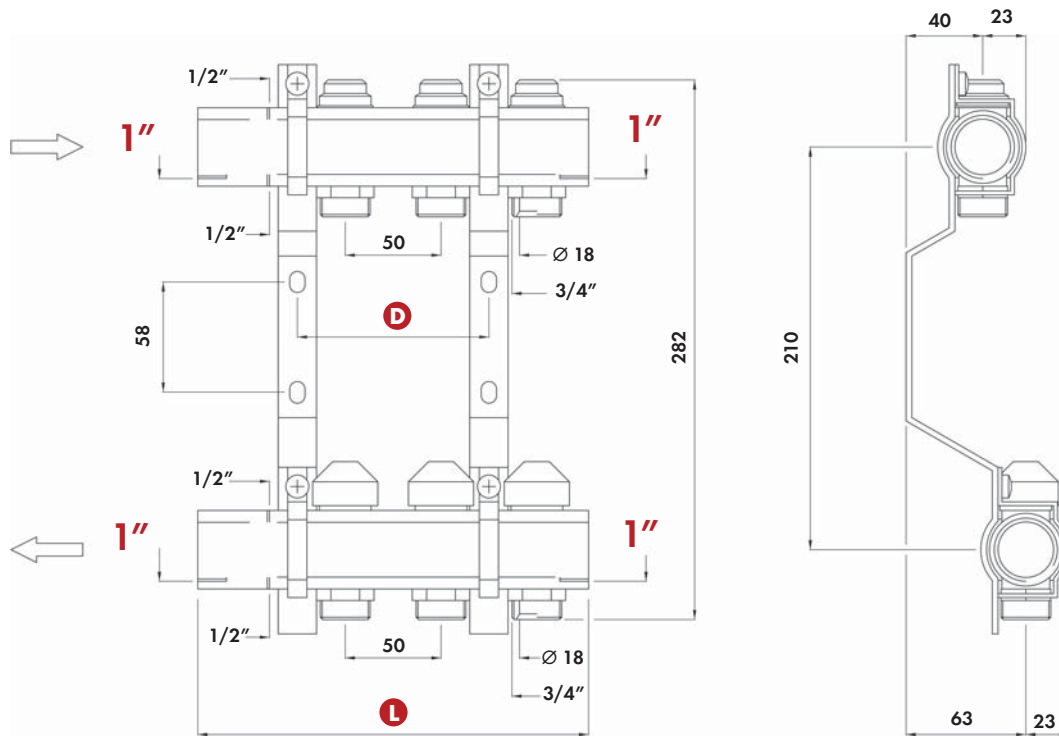

OVERALL DIMENSIONS

MANIFOLD CODE	N° OF OUTLETS	L (mm)	D (mm)	CABINET CODE
88.20.400	2	104	–	88.10.315
88.20.401	3	154	50	88.10.315
88.20.402	4	204	100	88.10.315
88.20.403	5	254	150	88.10.315
88.20.404	6	304	200	88.10.315
88.20.405	7	354	250	88.10.315
88.20.406	8	404	300	88.10.320
88.20.407	9	454	350	88.10.320
88.20.408	10	504	400	88.10.320
88.20.409	11	554	450	88.10.325
88.20.410	12	604	500	88.10.325

PREASSEMBLED DISTRIBUTION MANIFOLD FOR HEATING SYSTEM

Allows:

1. Accuracy when controlling and regulating the flow rate of the single circuits
2. Easy and instantaneous monitoring of the flow rate of the single circuits
3. Low friction loss
4. Shutting single circuits
5. Easy to install



CODE
88.20.411/421

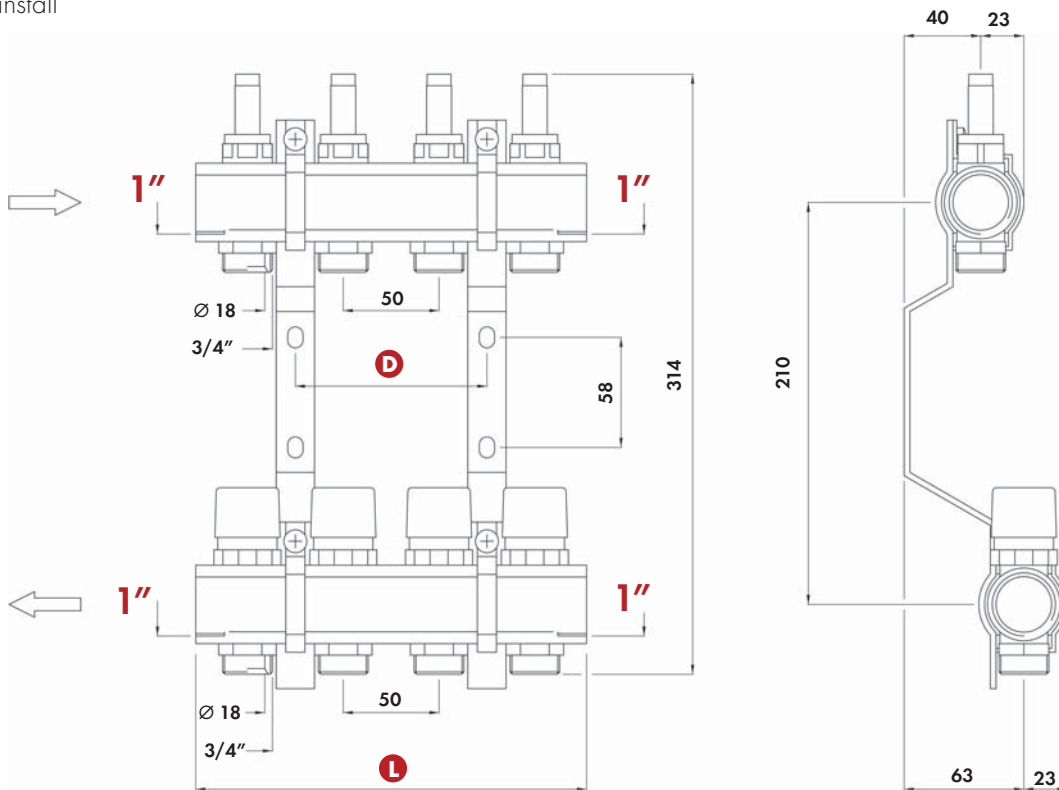

OVERALL DIMENSIONS

MANIFOLD CODE	N° OF OUTLETS	L (mm)	D (mm)	CABINET CODE
88.20.411	2	104	–	88.10.315
88.20.412	3	154	50	88.10.315
88.20.413	4	204	100	88.10.315
88.20.414	5	254	150	88.10.315
88.20.415	6	304	200	88.10.315
88.20.416	7	354	250	88.10.315
88.20.417	8	404	300	88.10.320
88.20.418	9	454	350	88.10.320
88.20.419	10	504	400	88.10.320
88.20.420	11	554	450	88.10.325
88.20.421	12	604	500	88.10.325

PREASSEMBLED DISTRIBUTION MANIFOLD FOR HEATING SYSTEM

CODE
88.20.422/432

Allows:

1. Accuracy when controlling and regulating the flow rate of the single circuits
2. Easy and instantaneous monitoring of the flow rate of the single circuits
3. Low friction loss
4. Shutting single circuits
5. Easy to install

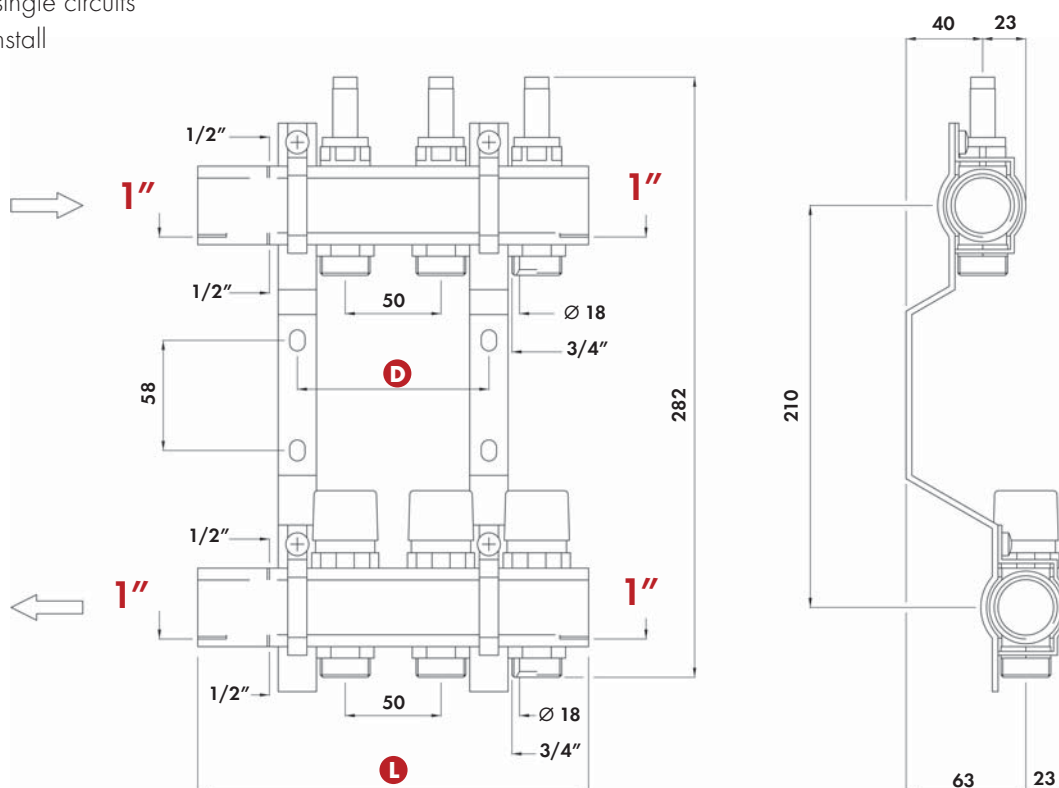

OVERALL DIMENSIONS

MANIFOLD CODE	N° OF OUTLETS	L (mm)	D (mm)	CABINET CODE
88.20.422	2	104	50	88.10.315
88.20.423	3	154	100	88.10.315
88.20.424	4	204	150	88.10.315
88.20.425	5	254	200	88.10.315
88.20.426	6	304	250	88.10.315
88.20.427	7	354	300	88.10.315
88.20.428	8	404	350	88.10.320
88.20.429	9	454	400	88.10.320
88.20.430	10	504	450	88.10.320
88.20.431	11	554	500	88.10.325
88.20.432	12	604	550	88.10.325

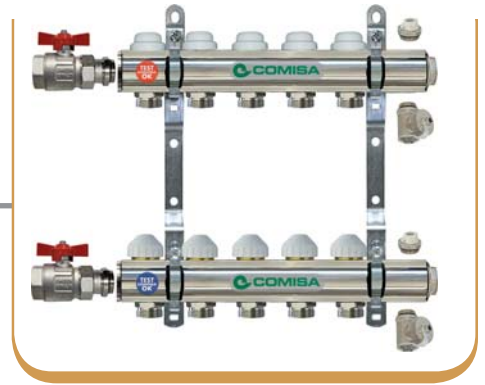

CODE
88.20.433/443

Allows:

1. Accuracy when controlling and regulating the flow rate of the single circuits
2. Shutting flows in outlet and/or inlet manifolds
3. Low friction loss
4. Shutting single circuits
5. Easy to install

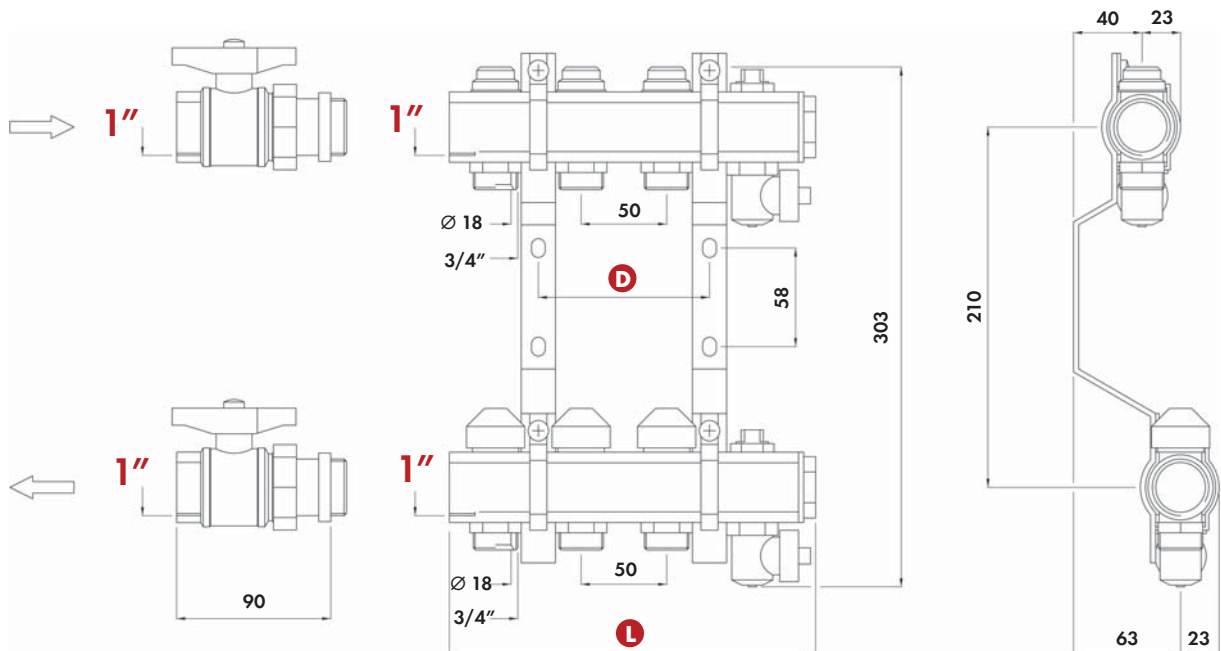

OVERALL DIMENSIONS

MANIFOLD CODE	N° OF OUTLETS	L (mm)	D (mm)	CABINET CODE
88.20.433	2	114	–	88.10.315
88.20.434	3	164	50	88.10.315
88.20.435	4	214	100	88.10.315
88.20.436	5	264	150	88.10.315
88.20.437	6	314	200	88.10.315
88.20.438	7	364	250	88.10.315
88.20.439	8	414	300	88.10.320
88.20.440	9	464	350	88.10.320
88.20.441	10	514	400	88.10.320
88.20.442	11	564	450	88.10.325
88.20.443	12	614	500	88.10.325

PREASSEMBLED DISTRIBUTION MANIFOLD FOR HEATING SYSTEM

Allows:

1. Accuracy when controlling and regulating the flow rate of the single circuits
2. Easy and instantaneous monitoring of the flow rate of the single circuits
3. Low friction loss
4. Shutting single circuits
5. Shutting flows in outlet and/or inlet manifolds
6. Easy to install

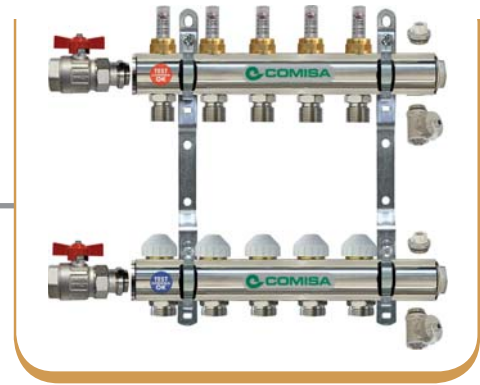

CODE

88.20.444/454

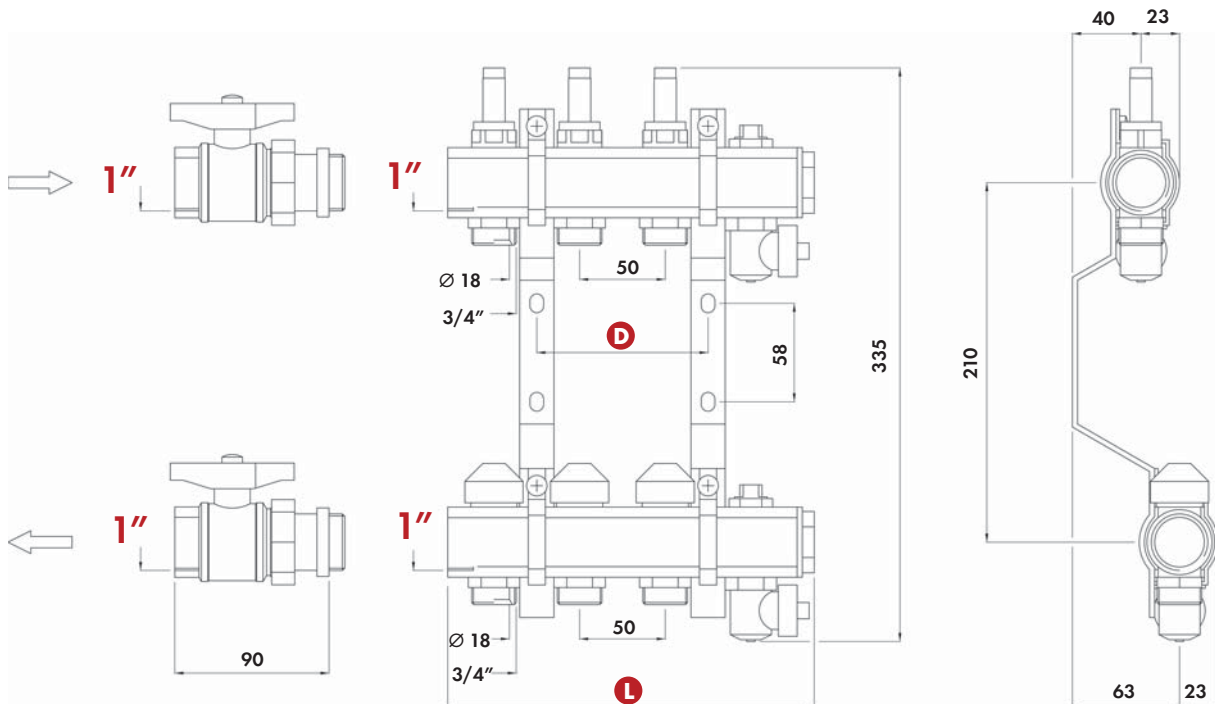

OVERALL DIMENSIONS

MANIFOLD CODE	N° OF OUTLETS	L (mm)	D (mm)	CABINET CODE
88.20.444	2	114	–	88.10.315
88.20.445	3	164	50	88.10.315
88.20.446	4	214	100	88.10.315
88.20.447	5	264	150	88.10.315
88.20.448	6	314	200	88.10.315
88.20.449	7	364	250	88.10.315
88.20.450	8	414	300	88.10.320
88.20.451	9	464	350	88.10.320
88.20.452	10	514	400	88.10.320
88.20.453	11	564	450	88.10.325
88.20.454	12	614	500	88.10.325

T ECHNICAL DATA SHEET

INLET MANIFOLD

OUTLET MANIFOLD
WITH **HOLDERS**

OUTLET MANIFOLD
WITH **FLOWMETERS**

Inlet manifold

TECHNICAL FEATURES

PERFORMANCE

ALLOWED FLUIDS	WATER, GLYCOL SOLUTIONS
MAX GLYCOL %	30%
MAX PRESSURE	10 BARS
MAX TEMPERATURE	90° C
OPERATING TEMPERATURE	80° C

REGULATION OF Kv

N° of rotations	3
Kv	3.46

INLET MANIFOLD FRICTION LOSS

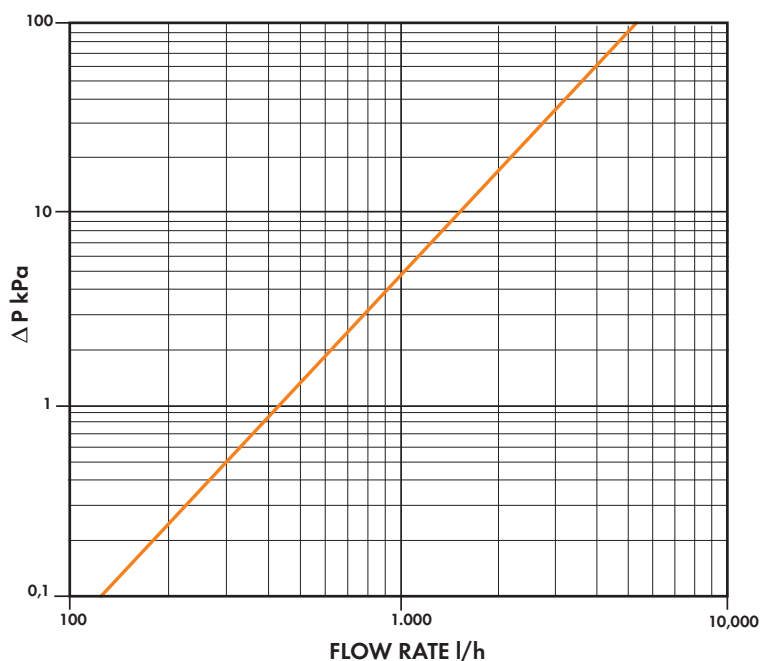

THERMOSTATICALLY-CONTROLLED COLUMN

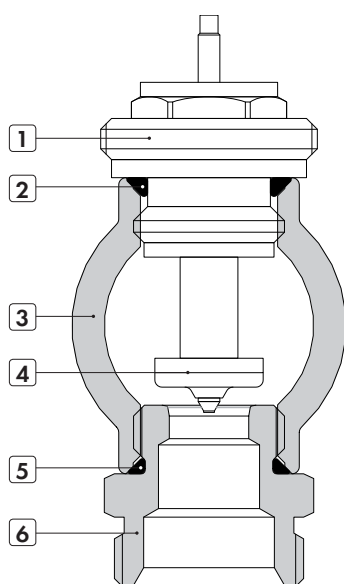

INLET MANIFOLD MATERIAL

1	BODY	CW 617N BRASS
2	O-RING	EPDM 70 SH
3	MANIFOLD BODY	CW 617N BRASS
4	PLUG	EPDM 70 SH
5	O-RING	EPDM 70 SH
6	3/4" FITTING	CW 617N BRASS

Outlet manifold with holders

TECHNICAL FEATURES

PERFORMANCE

ALLOWED FLUIDS	WATER, GLYCOL SOLUTIONS
MAX GLYCOL %	30%
MAX PRESSURE	10 BARS
MAX TEMPERATURE	90° C
OPERATING TEMPERATURE	80° C

REGULATION (N° OF ROTATIONS FROM THE PLUG COMPLETELY CLOSED POSITION)

N° of rotations	0,5	1,5	2,25	2,75	3,5	5	6,25	7	7,5	8	TA
Kv	0,13	0,28	0,48	0,6	0,97	1,15	1,3	1,45	1,59	1,69	1,77

HOLDER FRICTION LOSS

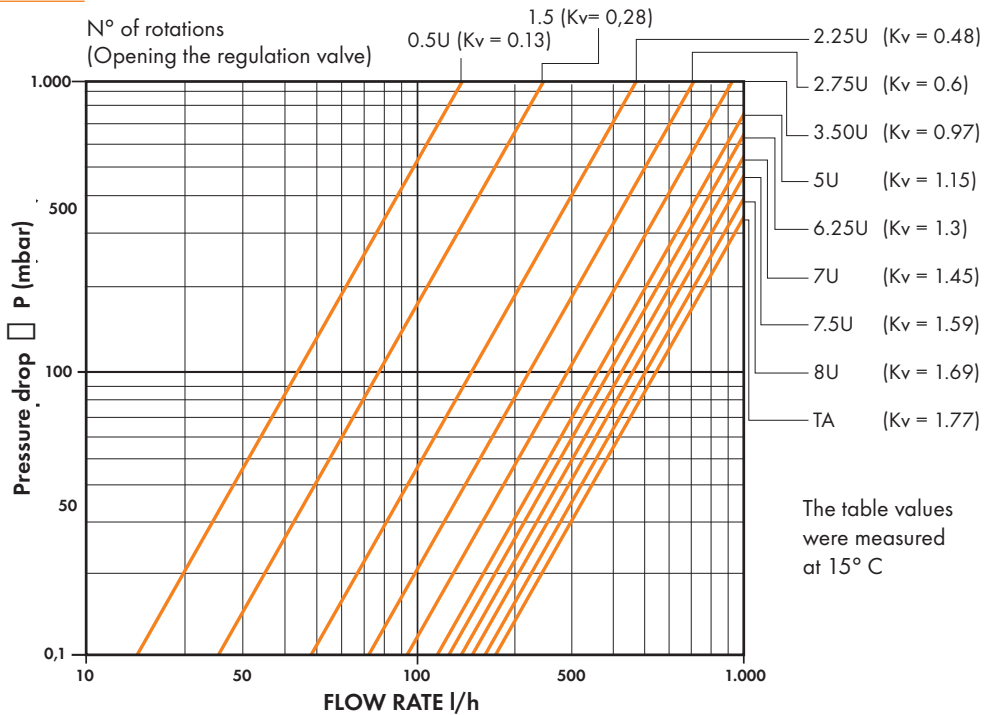

DETENTORE

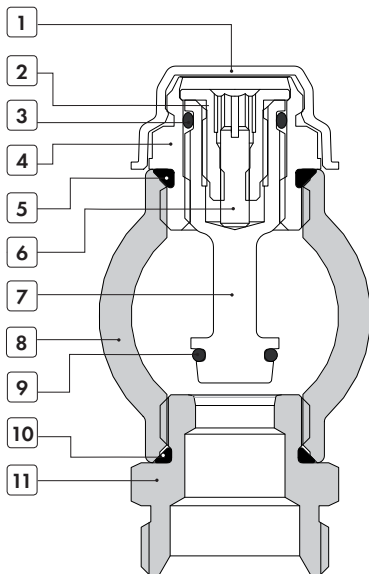

OUTLET MANIFOLD WITH HOLDERS MATERIAL

1	CAP	POLYPROPYLENE
2	HOLDER BODY	NYLON 12
3	O-RING	EPDM 70 SH
4	HOLDER BODY	CW 617N BRASS
5	O-RING	EPDM 70 SH
6	DOWEL	CW 617N BRASS
7	PLUG	CW 617N BRASS
8	MANIFOLD BODY	CW 617N BRASS
9	O-RING	EPDM 70 SH
10	O-RING	EPDM 70 SH
11	3/4" FITTING	CW 617N BRASS

Outlet manifold with FLOWMETERS

TECHNICAL FEATURES

PERFORMANCE	
ALLOWED FLUIDS	WATER, GLYCOL SOLUTIONS
MAX GLYCOL %	30%
MAX PRESSURE	10 BARS
MAX TEMPERATURE	90° C
OPERATING TEMPERATURE	80° C
RANGE OF MEASUREMENT	From 0 to 6 Lit/min
COEFFICIENT OF MAXIMUM FLOW RATE	Kvs = 1.8
INDICATION ERROR	± 10% f.s. i.e. ± 0.6 Lit/min
OPERATION ΔP	The pressure difference at the ends of the flowmeter may vary between 10kPa (1.45 PSI) and maximum of up to 50 kPa (7.25 PSI) to obtain the reading with a 10% full scale maximum error
MAX SEEPING	<= 0.02% Kvs with plug closed
RECOMMENDED TORQUE FOR FASTENING THE Flowmeter ON THE MANIFOLD IN CASE OF REPLACEMENT	30 Nm

FLOWMETER FRICTION LOSS

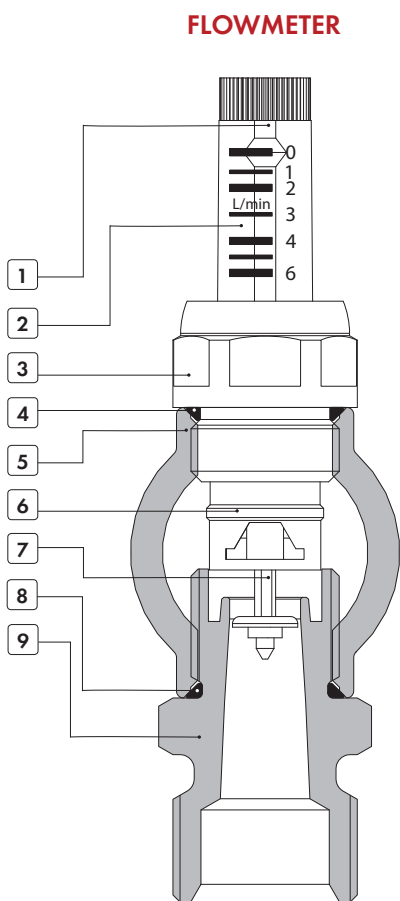
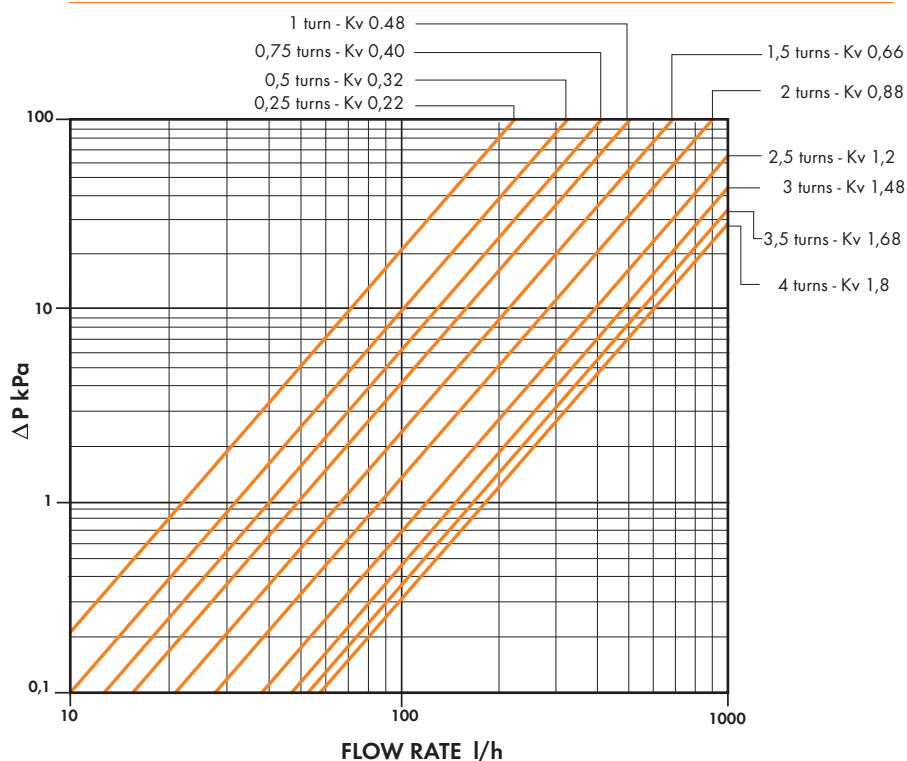

OUTLET MANIFOLD WITH FLOWMETER MATERIAL

1	LEVEL INDICATOR	NYLON 12
2	GRADUATED PIPE	NYLON 12
3	BODY	CW 617N BRASS
4	O-RING	EPDM 70 SH
5	MANIFOLD BODY	CW 617N BRASS
6	PLUG	NYLON 12
7	LEVEL BAR	NYLON 12
8	O-RING	EPDM 70 SH
9	3/4" FITTING	CW 617N BRASS